

Operating, maintenance and repair
instructions for

MAXIMATOR[®]
Compressors
DLE 5-1-2



MAXIMATOR GmbH
Walkenrieder Straße 15
37449 Zorge

Phone: +49-55 86-80 30
Fax: +49-55 86-8 03 40

E-Mail: Info@maximator.de
Homepage: www.maximator.de

1 Index

1	Index	2
2	Mode of operation	3
3	Safety instructions	4
3.1	Usage to the intended purpose	4
3.2	Emission	4
3.3	Safety hazards	4
3.4	Safety at the place of assembly	5
4	Technical data	5
4.1	Dimension drawing	5
5	Mounting	7
5.1	Assembly	7
5.2	Compressed air system	7
5.2.1	Compressed air quality	7
5.2.2	Compressed air oiler	7
5.2.3	Line cross-sections	7
5.2.4	Direct pilot valve air	8
5.3	High-pressure system	8
5.3.1	Inlet	8
5.3.2	Pressure line	8
5.3.3	Pumping medium	8
5.4	Operation	8
6	Maintenance	9
7	Warranty	9
8	Repair	9
8.1	High-pressure sealing repair	10
8.1.1	Dismantling	10
8.1.2	HP piston assembly	13
8.1.3	HP cylinder assembly	16
8.2	Repair of air drive parts and pilot valves	18
8.2.1	Dismantling	18
8.2.2	Assembly	23
8.3	Repair of suction and delivery valves	32
8.3.1	Dismantling	32
8.3.2	Assembly	35
8.4	Spool valve	39
8.4.1	Dismantling	39
8.4.2	Assembly	41

2 Mode of operation

As a rule, the MAXIMATOR compressors operate according to the pressure intensifier principle: large surface area with a low pressure (air piston(3)) → small surface area with a high pressure (HP piston(2)). A continual flow is attained by continuous pulsation. This pulsation is achieved by an impulse-controlled 4/2-way valve (servo-valve(4)). The servo-valve alternately impinges the top and bottom side of the air pistons. The servo-valve is selected via two 2/2-way valves (pilot valves(7)) that are mechanically by the air piston in its end positions. The pilot valves ventilate and vent the actuation chamber of the servo-valve. The drive air provides the restoring force for the servo-valve. In the actuation chamber the servo-valve has a larger effective surface area than in the control chamber that is permanently impinged with compressed air. The HP piston generates the volume flow by means of check valves (suction valve, delivery valve(1)). The HP section of the compressors consists of two stages. The first stage has a low pressure ratio and conveys directly into the second stage with a high pressure ratio. These two stages allow for the generation of a high operating pressure with sufficient compressor capacity, even with a low admission pressure. The initial pressure depends on the adjusted drive pressure. The below formula:

$$P_B = i_2 * P_L + \frac{i_2}{i_1} * P_A$$

where:

P_B : Operating pressure

P_L : Drive pressure

P_A : Admission pressure

i : Pressure ratio

is used to calculate the static final pressure. Upon reaching the final pressure the compressor stops and ceases to consume air. Only a pressure drop at the high-pressure side or a pressure increase at the drive side occasion the compressor to re-start.

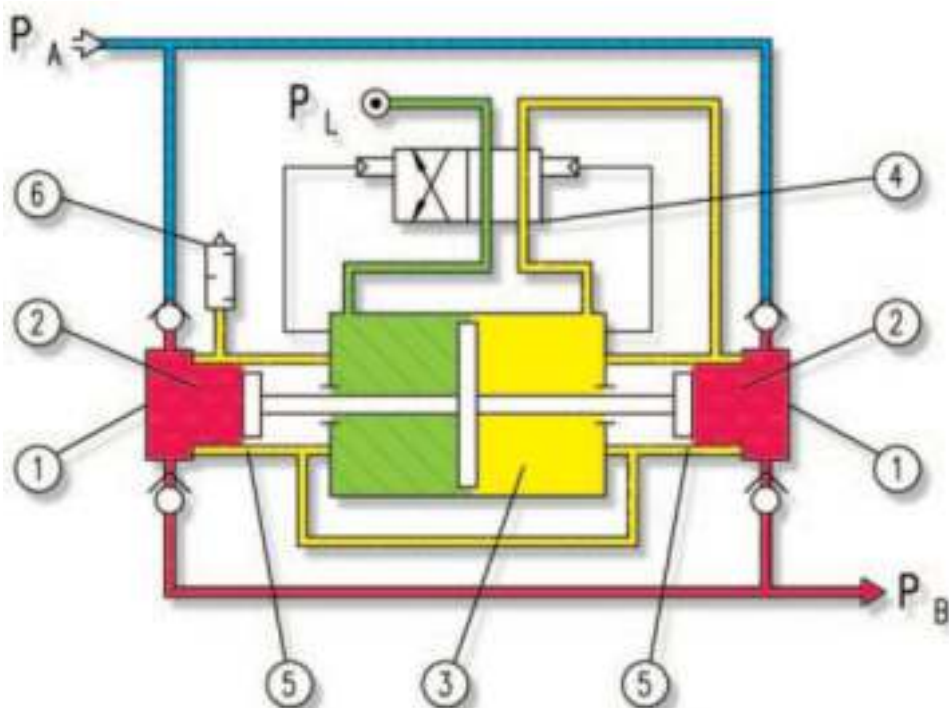

3 Safety instructions

MAXIMATOR compressors are manufactured to the latest state of the art and are safe to operate. However, there are potential hazards in case of inadvertent wrong operation or wrong use:

- For the health and lives of persons.
- For the compressor and its accessory parts as well as other assets.
- For the life cycle and the performance capacity of the compressors and its accessory parts.

Operation, maintenance and assembly of the compressor may only be carried by personnel who are familiar with working on pneumatic systems and are familiar with the hazards entailed by such systems. In addition, the operating instructions shall be thoroughly studied and adhered to.

3.1 Usage to the intended purpose

The compressors may be exclusively used with those media for which they are suitable according to our media endurance schedule. Any other media have to be tested by us for compatibility with the compressor materials prior to being used. The compressor drives are designed for compressed air up to 10 bar, other gases have to be tested by us for compatibility with the compressor materials prior to being used.

Changes and modifications of the compressors are prohibited for safety reasons.

All maintenance, assembly and operating instructions specified in these operating instructions must be adhered to in order to guarantee full functioning and safety.

3.2 Emission

Expanding compressed air is, depending on the specific application, prone to generate a certain level of noise. Moreover, exhausting air from the silencer may be fouled with water and oil (grease). It is also possible that small ice crystals form at the silencer, become loose and fly around. This is why persons have to wear goggles and, if need be, ear protection while in the vicinity of running compressors.

3.3 Safety hazards

During operation of the unit, both the drive part and the high-pressure part are under pressure. Hence, it should be borne in mind that any gas that may leak due to a defect or also during normal operation are highly pressurised and must not be contained or deviated by objects or body parts. It must be ensured that in case of a defect a compressor is immediately depressurised and repaired.

Maintenance and repair work may only be carried out at depressurised units.

3.4 Safety at the place of assembly

MAXIMATOR compressors must not be operated in closed containers, since the discharged drive air may burst the container.

The high-pressure bolted connections at the suction and pressure sockets must not be unscrewed, even if this would facilitate the erection of the compressor. The bolted connections must be firmly tightened in order to avoid any leakages and damage.

The air drive has been designed in such manner that the compressors are safe to be operated in areas that subject to explosion hazards.

The compressor should be installed in such a manner that the operating elements and bolted connections are freely accessible at any time.

4 Technical data

Type	Pressure ratio i (i ₁ /i ₂)	Compression ratio	Admission pressure		Max. operating pressure	Turn-of-piston volume cm ³	Max. stroke frequency l/min	Threaded connection		Max. operating temperature °C	Weight kg
			Min.	Max.				Inlet*	Outlet*		
			bar		bar						
			P _A		P _B						
DLE 5-1-2	1:10	1:15	4	100	100	373	110	BSP 1/2	BSP 1/2	60	22

4.1 Dimension drawing

MAXIMATOR
 Maßzeichnung / Dimension drawing
 Typ / type: DLE 5 - 1 - 2

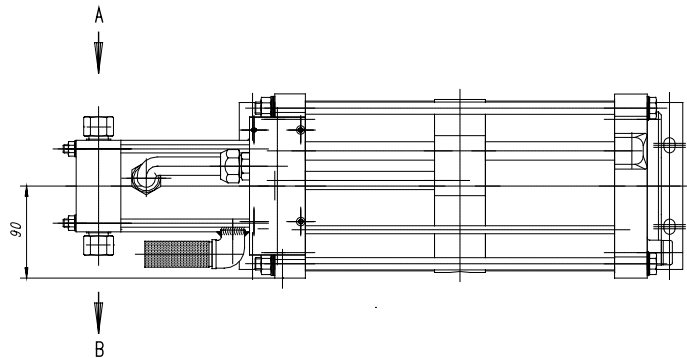
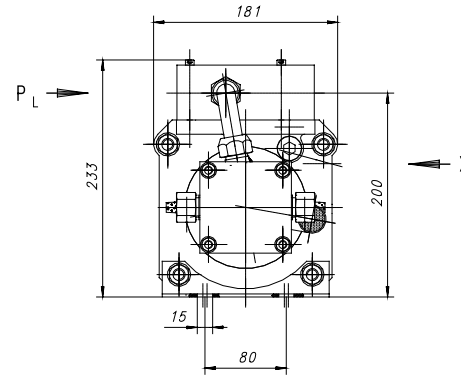
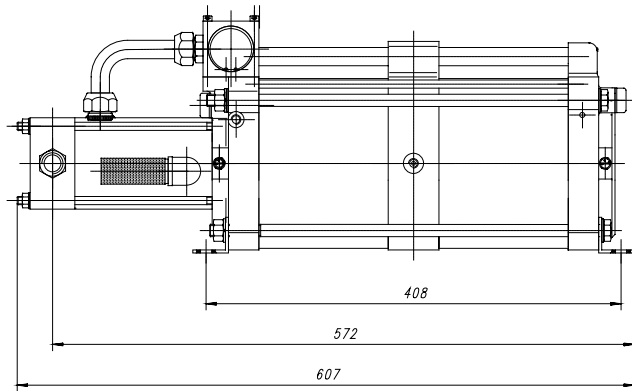

- Antriebslufteinlaß...P_L = G3/4 (3/4BSP)
(air drive inlet)
- Gaseinlaß.....A = G1/2 (1/2BSP) >1/2NPT<
(gas inlet)
- Gasauslaß.....B = G1/2 (1/2BSP) >1/2NPT<
(gas outlet)
- Steuerluftanschluß....X = G1/8 (1/8BSP)
(external pilot con.)

Bei allen über Fertigungsmaschinen: Länge- und Hakenweite nach DIN ISO 2768-m Bohr- und Schraubebohrungen nach DIN ISO 2768-m Toleranzen für Maße und Längen nach DIN ISO 2768-m Oberflächenrauheit nach DIN ISO 2768-m Angaben nach DIN 8724		MAXIMATOR MAXIMATOR GmbH D-99734 Nordhausen / D-37449 Zorge	
Name:		Maßstab: 1:2 Gewicht:	
Material:		DLE 5 - 1 - 2	
Datum:		(Abmessung) MAXIMATOR - DLE	
Zeichnung:		einfachwirkend / zweistufig	
Maßstab:		(Zeichnungsnummer) VP 16.00.259	
Hersteller:		(Artikel-Nr.) (3210.)	
Zustimmung:	Datum:	Skizze:	Kreuzt. Nr.:

5 Mounting

5.1 Assembly

The mounting position of the compressor is optional. It must be ensured that there is no ingress of foreign matter into the connections of the compressor during assembly (e.g. boring dust during wall mounting). Hence, the blind plugs in the connections of the compressor should only be removed immediately before fastening the respective connections.

5.2 Compressed air system

We recommend the use of one of our air control units for compressed air supply. The units consist of a filter, water separator, shut-off valve, pressure controller, pressure gauge and, where appropriate, a safety valve. If there is no maintenance unit employed it must be ensured that the compressed air quality complies with our specifications.

5.2.1 Compressed air quality

- Solid matter:
 - Max. particle size: 5 μ m
 - Max. particle concentration: 5mg/m³
- Dew point
 - + 10°C = water content 9.4g/m³
 - up to +2°C = water content 5.6g/m³

5.2.2 Compressed air oiler

As a rule, a compressed air oiler is not required. All moving parts have been treated with special grease during assembly.

The grease may become gummy when the compressor is operated for a longer period of time with extremely dry air. It is recommended to replace the compressed air oiler in such a case.

Caution! If the compressor has been operated with a compressed air oiler it must not be later used without an oiler because the oil washes all grease out of the compressor and thus prevents permanent lubrication. The remedy is re-lubrication with MAXIMATOR grease.

If a compressed air oiler is used, the oil content of the air should be 1mg/m³ to 5mg/m³.

5.2.3 Line cross-sections

The air supply should not be dimensioned smaller than the threaded connection, a reduction to a smaller threaded connection may result in performance losses and malfunctions of the pump. Also excessively long supply lines may cause problems due to the pressure drop in a small line.

5.2.4 Direct pilot valve air

The compressors are designed for operation with direct pilot valve air which should be connected downstream of the pressure controller, if applicable. Thus, the pump can reverse better with small drive pressures. The compressor does not operate unless the direct pilot valve air is connected.

5.3 High-pressure system

The employed HP piping and accessory parts must be matched in their pressure and cross-section to the compressor, otherwise the efficiency and safety of the compressor may be impaired.

5.3.1 Inlet

In order to achieve economic compressor output capacities and the indicated end pressures, the compressors have to be impinged with an admission pressure of the gas to be compressed. Only compressors with a pressure ratio of 2 can operate without admission pressure.

If there is no admission pressure available, an optimal compressor performance can only be realised with an underpressure-tight suction line. Otherwise the conveyed medium may be contaminated by ambient air. Cutting-ring bolted connections are not suitable.

A filter with a mesh width of max. 10µm should be installed into the suction line to avoid damage at the suction and delivery valves as well as at the HP sealing.

5.3.2 Pressure line

The pressure line and the respective accessories must withstand the max. initial pressure of the compressor. It is recommended to install an appropriate safety valve into the pressure line.

5.3.3 Pumping medium

The compressors shall be exclusively used with media that are suitable according to our media endurance schedule. Any other media have to be tested by us for compatibility with the compressor materials prior to being used.

5.4 Operation

The compressor starts to deliver as soon as drive air as well as direct pilot valve air are available.

Escaping drive air is used in compressors with a higher pressure ratio to cool down the HP parts. However, when a compressor is running in continuous operation with a high stroke frequency, there may be considerable heating up of the compressor despite cooling. This may result in increased wear of the sealings. It is recommended to monitor the temperature of the compressed gas in order to avoid overheating. Temperatures above 100°C at the compressor outlet should be avoided.

6 Maintenance

The air drives of all compressors have been pre-treated with heavy-duty grease and do not require any other type of lubrication. Only during overhauling of the compressor, the servo-valves and air pistons should be treated with acid- and silicon-free Maximator grease.

7 Warranty

We grant a warranty for the material and manufacturing quality of our products of six months commencing upon the shipping date of the unit.

Defects that may be caused by inappropriate handling or malfunctions, the use of inadmissible liquids, foreign matter in drive or pumping media or be exceeding the max. operating pressure are not subject to warranty. Wearing parts, such as sealings, guide elements, etc., are exempted from our warranty.

8 Repair

All repair work is to be carried out by qualified skilled personnel under extremely clean conditions. Even smallest impurification may cause serious damage at the precision-machined pneumatic components.



All individual pump and compressor parts are available from MAXIMATOR as spare parts. The respective purchase order numbers can be gathered from the drawings attached to each compressor. Typically, there is more than one sealing defective or worn out, hence, we have compiled different sealing kits. The compositions of sealing kits can be gathered from the drawings, like the respective purchase order numbers. Make sure to indicate the compressor serial number when ordering spare parts. The serial number is located in the machine plate of the compressor and is also punched into the compressor housing (as a 6-digit number).

It goes without saying that the most convenient approach for you is to ship a defective unit to us. All repairs are carried out by qualified persons in our workshops, where there are no metal-cutting activities and thus extreme cleanliness is ensured. As a rule we acknowledge the receipt of the forwarded unit and send you a cost estimate and, after your confirmation, repair your unit as quickly as possible and return it to you.

Note: Via our Homepage, you can access detailed repair instructions and drawings of the individual compressors that are to provide support to you during repair work or in case of any problems.

8.1 High-pressure sealing repair

8.1.1 Dismantling

	<p>Loosen the four hexagon nuts from the stud bolts.</p>
	<p>Carefully separate the compressor head by means of light taps with a plastic hammer from the HP cylinder.</p>
	<p>Loosen the HP cylinder by means of light taps with a plastic hammer from the top cover.</p>
	<p>Draw the HP cylinder from the HP piston.</p>

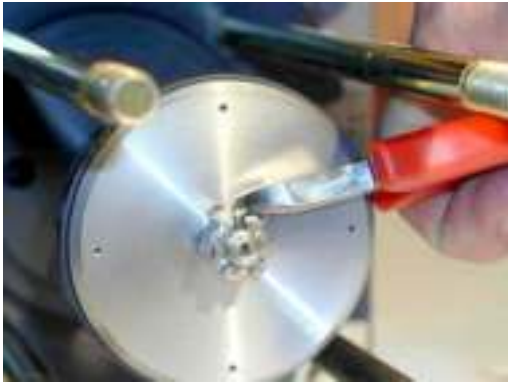

Remove the retaining pin of the castle nut.



Loosen the castle nut. If the HP piston follows to turn, it is recommended to use an impact screwdriver to loosen the castle nut.



Remove the piston disk.

Remove the piston sealing ring and O ring from the HP piston.



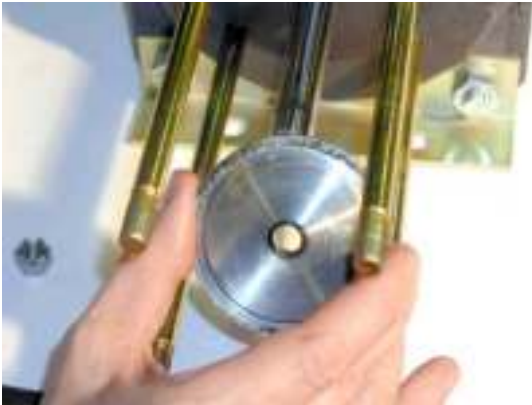

Draw the HP piston from the piston rod.



Remove the O ring from the HP piston.



Remove the O rings of the HP head.



Dismantle the O ring that seals the HP cylinder.

8.1.2 HP piston assembly

Clean all re-used components and inspect them for any damage.

Slightly grease all sealing and guide elements.
Use preferably MAXIMATOR grease Works No. 3610.1456.

Grease the top and bottom cover the O rings that seal the HP part and assemble the rings (first and second stage).



Attach the HP piston to the piston rod.

Grease the O ring and insert it into the groove between HP piston and piston rod.



Grease the O ring and mount it into the HP piston.

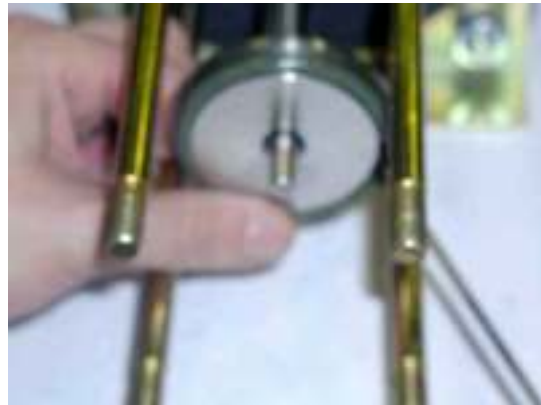

Grease the HP cylinder.



Insert the piston sealing ring into the HP cylinder and align the ring parallel ca. 13 mm below the cylinder edge.



Push the HP cylinder over the HP piston until the piston sealing ring fits close to the O ring.



Attach the piston disk.



Attach the spring lock washer and the castle groove.



Tighten the castle groove with 25 Nm. The piston sealing ring is pushed onto the O ring during tightening.

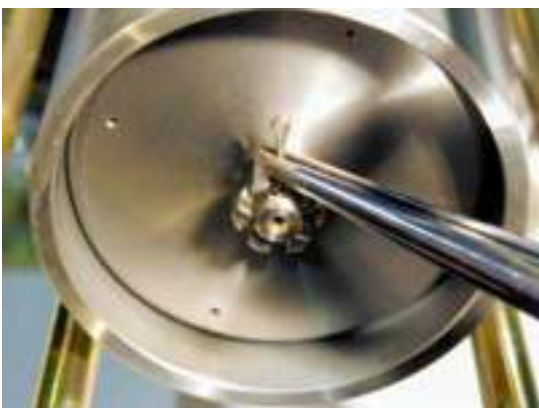

Use the retaining pin to secure the castle nut (appropriately bend the retaining pin with a screwdriver).

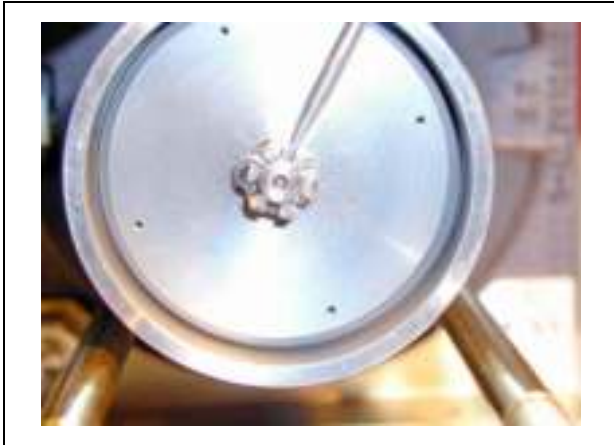

8.1.3 HP cylinder assembly

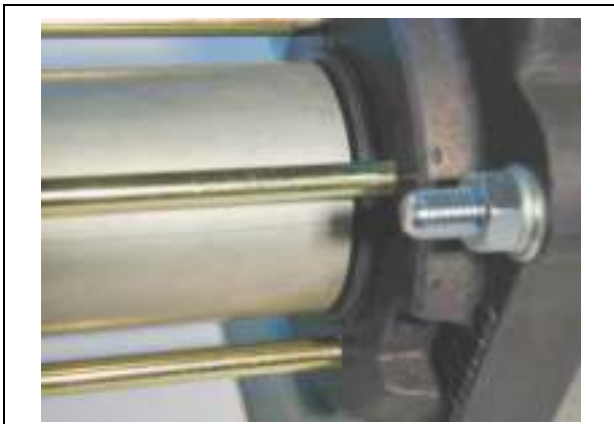

Push the HP cylinder over the O ring of the top cover till to the stopper.
Caution: Make sure not to damage the O ring.

Grease and mount the O rings that seal the HP head.



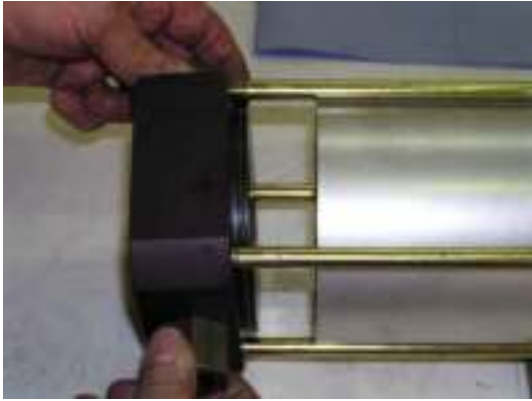

Push the compressor head over the stud bolts. Make sure that the suction and pressure lines can be mounted without any warping.



Attach the hexagon nuts and screw retainers to the stud bolts. (Do not tighten!)

8.2 Repair of air drive parts and pilot valves

The HP parts have to be dismantled before the air drive parts can be disassembled.

8.2.1 Dismantling

8.2.1.1 Dismantling of the air drive

Remove the servo-valve and the air pipe, loosen the 4 socket head screws.



Remove the four hexagon nuts from the hexagon bolts.

Draw the bottom cover from the air cylinder. Now also the pressure pipe can be dismantled.
Caution: The piston rod must not be withdrawn from the top cover because it may get jammed in the end groove.

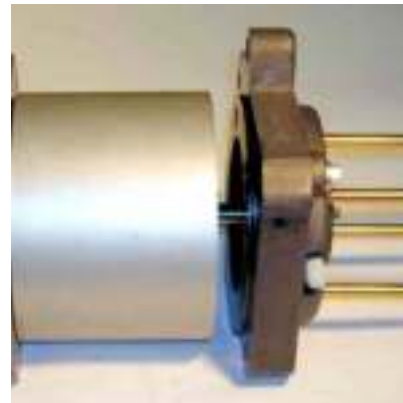

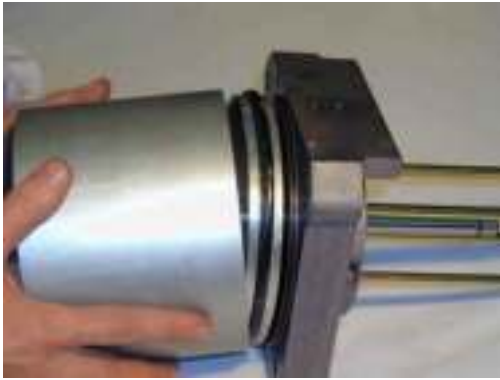

Withdraw the air cylinder from the top cover and the air piston.

Pull the air piston slightly out of the top cover and remove the retaining pin and bolts.

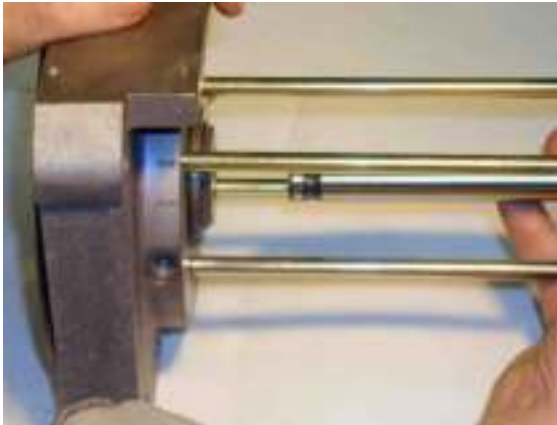

Pull the piston rod out of the top cover into the direction of the HP part.



Remove the O ring from the air piston.

8.2.1.2 Dismantling of top cover and bottom cover



Remove the locking ring.

Knock the bearing bush out of the top and bottom covers by means of a plastic mandrel.



Remove the O rings from the bearing bush.

Remove the sliding rings and O rings from the bearing bush.





Dismantle the O ring that seals the air cylinder.



Dismantle the O rings for the control pipe from the top and bottom covers.



Remove the O rings from the pressure pipe.

Loosen completely and unscrew the pilot valve screw.





Withdraw the USIT ring, compression spring and pilot valve tappet.

Turn the top cover round in order to lever out the serrated ring, washer and O ring by means of a small screwdriver. The components are destroyed in the process.



8.2.2 Assembly

8.2.2.1 Assembly of the top and bottom covers

 <p>Wedging mandrel</p> <p>Centring mandrel</p>	<p>The following tools are necessary to re-assemble the pilot valves: A centring mandrel, Works No. 3610.0284, and a wedging mandrel Works No. 3610.0285</p>
	<p>Slip the serrated ring, washer and O ring in this order onto the centring mandrel. When attaching the serrated ring, make sure that the serration points away from the O ring.</p>
	<p>To begin with, insert the centring mandrel into the tappet boring. Then drive the entire package with some hammer strokes into the boring.</p> <p>Caution: Make sure that the O ring is fully attached to the bottom.</p>

Grease and re-insert the pilot valve tappet. During assembly a tangible resistance must be felt from the previously mounted O ring.



Slip the compression spring onto the pilot valve tappet.

Insert the USIT ring into the boring. Then tighten the pilot valve screw with a torque of 25Nm.



Now turn the top cover round. Then use the wedging mandrel to safeguard the serrated ring against slipping out. Upset the boring with a few hammer strokes.



Insert the O ring into the bearing bush.



Form the sliding ring into a kidney shape and insert it. Subsequently, bring the sliding ring inside the groove back into its original form. Caution: Do not bend the sliding ring too sharply.





Then mount the two O rings into the grooves at the external diameter of the bushing.

Grease the boring in the cover and insert the bushing with pressure.
Caution: Make sure not to inadvertently remove the O rings





Insert the locking ring into the foreseen groove. Check also for its correct seat.



Mount the O ring that seals the air cylinder.

8.2.2.2 Air drive assembly

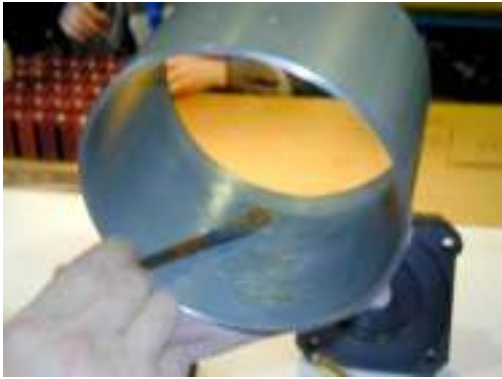
	<p>Grease the bearing bush of the bottom cover.</p>
	<p>Insert the air piston with piston rod into the bottom cover.</p>
<p>Grease and attach the O ring for the air piston.</p>	
	
	<p>Grease the air cylinder.</p>

Attach the air cylinder onto the air piston, carefully insert the O ring into the cylinder while doing so. Push the air cylinder and the bottom cover together until the air cylinder fits closely to the bottom cover.



Carefully move the piston rod from outside through the greased bearing bush of the top cover. Caution: Make sure not to damage the sliding rings in the bearing bush in the process.



Insert the piston rod into the piston rod holder of the air pistons and fasten with the pin.





Safeguard the sub-assembly with the retaining pin.

Place the O rings for the capillary control tube into the top and bottom covers and use the capillary control tube to push the O ring into the boring till to the stopper.



Slightly push the top and bottom cover together and insert the capillary control tube.



Carefully push the air drive part together until the air cylinder fits closely to the top cover.



Attach washers and fastening brackets to the hexagon bolts and mount these assemblies. Caution: The hexagon bolt (longer design) is placed at the air supply side, marked with PL.



Also on the opposite side, the fastening brackets, screw retainers and washers are pre-assembled together with the hexagon nuts.

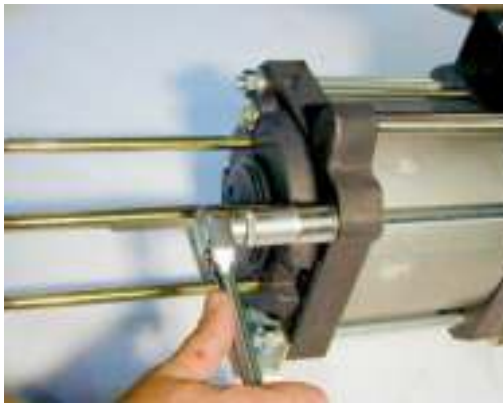

Tighten the bolts only slightly.



The DLE is placed on a workbench for alignment and a soft hammer is used to align the top and bottom cover in parallel.



Then tighten the hexagon nuts crosswise with the specified torque of 55 Nm.

Grease and slip on the O rings for the air pipe.



Re-attach the servo-valve with cooling tube and the air pipe, check the correct seat of the O rings.

8.3 Repair of suction and delivery valves

8.3.1 Dismantling

8.3.1.1 Suction valve

Loosen the inlet sockets. Pull out the entire valve unit by means of the inlet socket.



Use a mandrel to force the valve unit out of the inlet socket.



Remove the O ring from the valve seat.



Remove the O ring from the inlet socket.

The main parts of the suction valve are: Inlet socket, valve ball, spring, ball holder, valve seat and two O rings.



8.3.1.2 Delivery valve

Loosen the outlet sockets. The ball and spring fall out and the valve seat stays in the HP head.

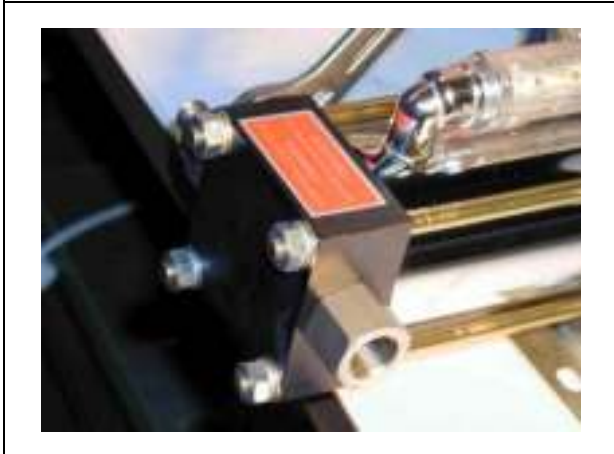

Use a mandrel to force out the valve seat, that is still in the HP head.

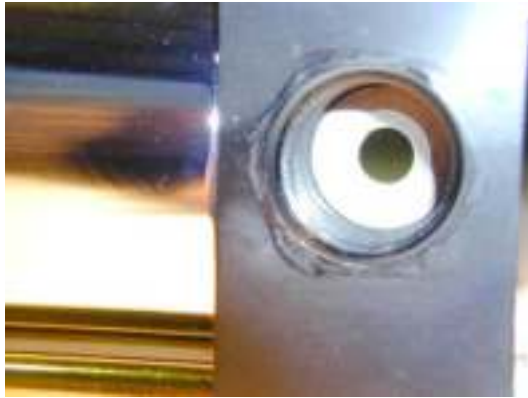

Remove the O ring that seals the valve seat.



Force the ball holder out of the outlet socket.



Remove the O ring from the outlet socket.

The main parts of the delivery valve are: Inlet socket, valve ball, spring, ball holder, valve seat and two O rings.



8.3.2 Assembly

8.3.2.1 Outlet valve

Grease the O ring and slip it onto the outlet socket.



Grease the O ring that seals the valve seat and insert the ring in to the HP head.





Use a cone-shaped mandrel to force the valve seat into the HP head.



Insert the ball into the valve seat.



Attach the spring on to the ball.



Push the ball holder over the spring.

Screw the outlet socket into the HP head. Make sure to check before the correct seat of the ball and the spring. Tighten the outlet socket with 120 Nm.



8.3.2.2 Inlet valve

Grease the O ring and slip it onto the inlet socket.



Grease the O ring that seals the valve seat and slip it onto the valve seat.



Place the valve seat and the ball onto the inlet socket and carefully press them into the socket.



Place the spring on top of the ball.



Slip the ball holder over the spring.

Screw the inlet socket into the HP head. Tighten the inlet socket with 120 Nm.

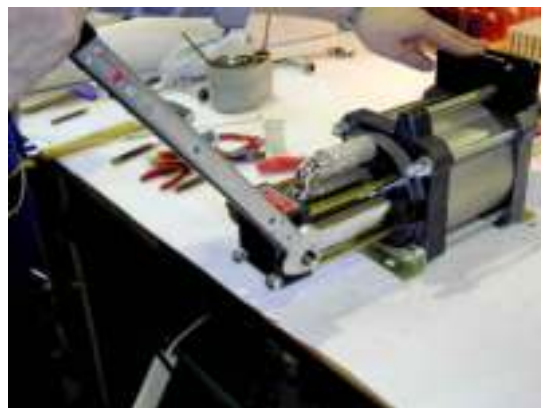

8.4 Spool valve

8.4.1 Dismantling

	<p>Loosen the socket head screws in the spool valve housing.</p>
	<p>The air pipes are only loosely pushed in and can smoothly be withdrawn from the spool valve housing and the intermediate cover.</p>
	<p>Remove the O rings that seal the top cover.</p>
	<p>Dismantle the locking ring at the spool valve housing with suitable locking ring pliers. (The ring is located opposite the compressed air inlet).</p>

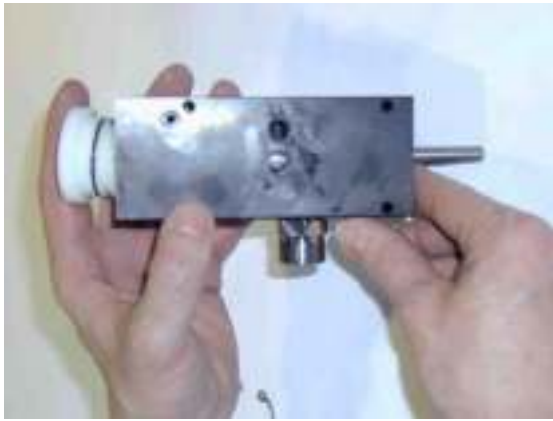

Use a mandrel to force out the spool valve sleeve with light strokes of the spool valve housing.
Caution: Make sure to avoid damaging the servo-spool.
Preferably use a plastic or wooden mandrel.

The O rings on the spool valve sleeve are statically sealing, i.e. they are not subject to wear and tear. This means that the spool valve sleeve has only to be dismantled when it is damaged. Use a mandrel to force the spool valve sleeve out of the spool valve housing.

Caution: Make sure to avoid damaging the spool valve sleeve. Preferably use a plastic or wooden mandrel with an appropriate diameter.



Remove the O rings from the spool and, if applicable, from the spool valve sleeve.





Remove the O ring from the sealing cap.

8.4.2 Assembly

Check all components for damage and replace them as required. There must not be any scoring at the spool valve sleeve.



Grease all O rings.



Slip the O rings onto the servo-valve, sealing cap and, if applicable, the spool valve sleeve.



Grease the spool valve sleeve well, even when it is still installed. Insert the spool with rotating motions into the spool valve sleeve.



If applicable, grease the spool valve housing internally and install the spool valve sleeve with slight rotating motions into the spool valve housing.



Re-insert the sealing cap into the spool valve housing and fasten it with the locking ring.

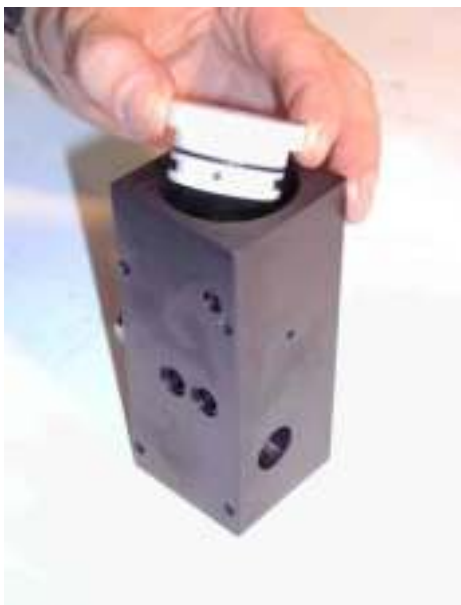

Use a small quantity of grease to “glue” the O rings for the sealing between spool valve housing and top cover into the O ring nests.



Re-attach the spool onto the DLE. During the process, guide the air pipes into the spool valve housing.



Place the 4 socket head screws to fasten the spool valve housing and tighten the screws with 5 Nm.