

AIR PILOT SWITCHES

PRESSURES FROM 145 TO 14,500 PSI

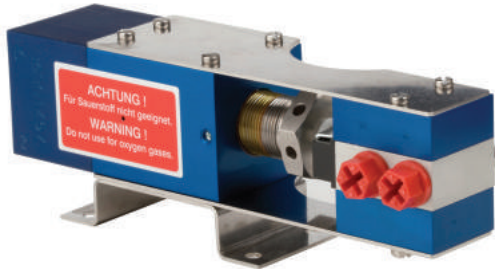

- Air pilot pressure switches are pressure sensing devices with an air valve, used to turn air driven gas boosters, liquid pumps and air amplifiers on/off at a desired set pressure by controlling a pneumatic signal to the unit's air pilot control feature.
- Units can operate at their maximum drive air pressure, achieving desired outlet set pressure as rapidly as possible.
- Switch resets in approximately 10% drop in set pressure, for the controlled unit restart.
- Externally adjustable under pressure
- Normally Open switches close upon reaching set pressure (typically used to stop on pressure increase when the desired high pressure is achieved).
- Normally Closed switches open upon reaching set pressure (typically used to stop unit on pressure decrease, such as low bottle supply pressure).

Air Pilot model generator

APS-.....-.....-.....-.....

Switch Position

- NO - Normally Open
- NC - Normally Closed

Special versions

- O2 - Cleaned for oxygen service, 316 stainless steel body
- SS - 316 stainless steel body

Connections (Air ports are 1/8" BSPP)

- 4B - 1/4" BSPP with outer seal
- 4P - 1/4" FNPT
- 4M - 1/4" Medium pressure coned and threaded

Pressure Ranges

- 10-30 - between 10 and 30 bar (145-435 psi)
- 30-100 - between 30 and 100 bar (435 - 1450 psi)
- 100-300 - between 100 and 300 bar (1450 - 4350 psi)
- 150-400 - between 150 and 400 bar (2175-5800 psi)
- 300-1000 - between 300 and 1000 bar (4350-14,500 psi)

Typically stocked switches

- APS-10-30-4P-NO
- APS-10-30-4P-NC
- APS-30-100-4P-NO
- APS-30-100-4P-NC
- APS-150-400-4P-NO
- APS-150-400-4P-NC
- APS-100-300-4P-NO
- APS-100-300-4P-NC
- APS-300-1000-4P-NO
- APS-300-1000-4P-NC
- APS-10-30-4B-O2-NC
- APS-100-300-4B-O2-NO

TECHNICAL INFORMATION

Materials

- Body (Standard).....Aluminum Alloy
- Body (Optional).....316 Stainless Steel
- Piston.....440-B
- Seal.....PTFE with T46 Turcon
- Gland.....303 SS
- O-Ring.....Buna-N

Connections

- Sensing Port.....1/4" FNPT
- Air Ports.....1/8" BSPP

Adjustment

Turn adjusting gland (32 mm hex) clockwise to increase, or counter clockwise to decrease the pressure setting. The gland hex also has holes for using a rod or Allen wrench. The dead-band is about 10% of the final set pressure.

DIMENSIONS (inches)

NOTE: Maximum inlet air pressure is 145 PSI
Weight is 3 lbs.

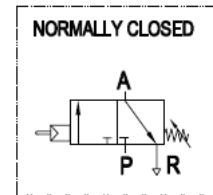
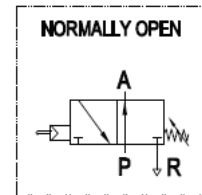
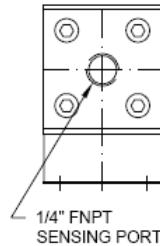
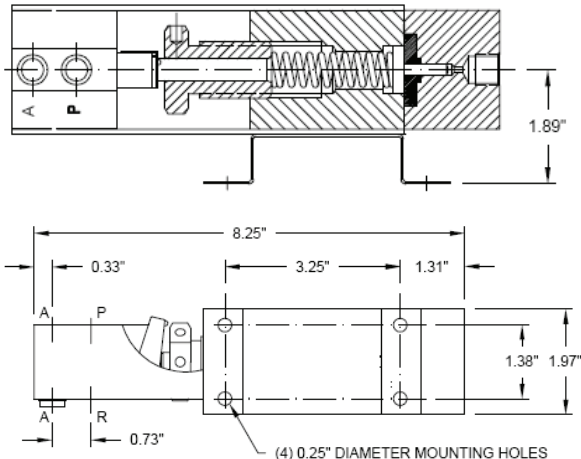

"A" = AIR OUTLET TO PILOT CONNECTION "X" OF PUMP OR BOOSTER (145 PSI MAXIMUM), 1/8" BSPP

"P" = AIR INLET FOR PILOT, 145 PSI MAXIMUM, 1/8" BSPP

"R" = RELEASE VENT OUTLET, 1/8" BSPP

SENSING PORT = 1/4" FNPT

NOTE: Dimensions are subject to change.
Consult Factory.

Pressure Relief Valves 3,000-10,000-25,000- 66,000 PSI

Maxpro proportional relief valves are designed to protect systems and components against over-pressure for both gas and liquid applications. The unique poppet design allows for chatter free pressure release and excellent deadband pressure control.

The soft seat design (MT3RV, MT10RV and MT25RV) provides bubble tight shut-off and increased cycle life.

These proportional relief valves are designed to open gradually as the pressure increases, they are not recommended for full capacity at a given pressure, and therefore are not certified to ASME code requirements.

Relief Valve Features:

- Gas or Liquid Service
- 316L Stainless Steel Body
- Nylon Seats (MT3RV, MT10RV & MT25RV)
- Seal materials are PTFE/EPDM
- Panel mounting
- Externally adjustable
- Safety weep hole for seal area leak detection
- Temperature Range -0°F to 200°F
- Factory pressure setting available
- Preset and locked cracking pressure “-L”
- **Repair Kits** - Consult your **MAXPRO** representative for repair kits and valve bodies. Refer to the Tools and Installation section for proper maintenance procedures.



Catalog Number	Connection Size		Orifice (in.)	Service	Pressure Rating (psi) @ R.T.		Valve Panel Hole	Body Diameter
	Inlet	Outlet			Minimum Setting	Maximum Setting		
MT3RV	14" FNPT (2)	1/4 FNPT	0.070	Liquid/Gas	500	3,000	1.38	1.50
MT10RV	1/4" FNPT (2)	1/4 FNPT	0.070	Liquid/Gas	1,000	10,000	1.38	1.50
MT25RV	1/4" H.P.	1/4 FNPT	0.070	Liquid/Gas	2,500	25,000	1.625	2.00
MT66RV	1/4" U.H.P.	1/4 FNPT	0.070	Liquid/Gas*	10,000	66,000	1.625	2.00

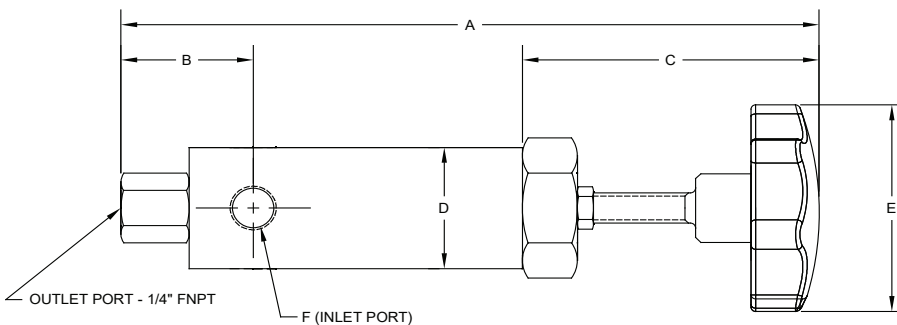

Dimension	MT3RV/ MT10RV	MT25RV	MT66RV
A	8.13"	9.94"	9.94"
B	1.56"	2.13"	2.13"
C	3.50"	1.68"	1.68"
D	1.50"	2.00"	2.00"
E	2.50"	.56"	.56"
F	1/4" FNPT	1/4" H.P.	1/4" U.H.P.

MT R5 05/2021

All general terms and conditions of sale, including limitations of our liability, apply to all products and services sold.

GAS RECEIVERS

Alloy Steel with nickel plating

1/4" high pressure inlet/outlet connections on each end.

Optional 1/4" NPT connections available.

- **REC-36S**....36 Cu. In. - 10,000 psi, 2.5" Dia. x 20.63" L overall
- **REC-66S**....66 Cu. In. - 10,000 psi, 2.5" Dia. x 33" L overall



DRY AIR SPOOLS

For severe duty service

- The Dry Air Spool (DAS) option should be considered for extreme operating conditions involving air or gas drive mediums below 0°F. dewpoint, or very cold climate applications (-40°C.).
- This option eliminates lubrication maintenance of the spool valve.



AIR RECEIVER TANKS

Carbon Steel, ASME Certified

- **T1-400**.....1 Gallon - 400 psi, no mounting, 6" OD x 16" L, 10 lbs., connections: (2) 3/4" FNPT (1) 1/4" FNPT
- **T4-600**.....4 Gallon - 600 psi, with mounting base, 10.75" Dia. x 13.75" H x 15" L, 46 lbs., connections: (2) 3/4" FNPT (3) 3/8" FNPT (2) 1/4" FNPT
- **T-302461**...10 Gallon - 200 psi, with mounting legs, 10" OD x 30" L. x 11.5" H, 43 lbs., connections: (2) 3/4"
- **T-302464**...15 Gallon - 200 psi, with mounting legs, 12" OD x 33" L, 14.5" H, 51 lbs., connections: (2) 3/4" FNPT (3) 1/2" FNPT (1) 1/4" FNPT
- **T-302470**...30 Gallon - 200 psi, with mounting legs, 16" OD x 38" L, 20.6" H, 111 lbs., connections: (2) 1 1/2" FNPT (3) 3/4" FNPT (1) 1/2" FNPT



AIR CONTROL PACKAGES

Consisting of a filter, regulator with gauge, shut-off valve and required fittings

- **ACM**....For all LC, PPO, PP & PPSF pumps, and MPLV air amplifiers
- **AC**.....For all S Pumps
- **ACP**....For all L, LO & LSF pumps, DLA & GPLV air amplifiers and DLE gas boosters
- **ACG**....For all GX pumps



PUMP CYCLE COUNTERS

To order: add suffix to pump P/N, eg. PPO12-CCW

- **CCP**....Panel mount, 0 - 999,999 max. cycles, 1" high x 2" wide hole
- **CCW**...Wall mount, 0 - 999,999 max cycles
 - Reset button



CLEANING FOR OXYGEN SERVICE

Meets or exceeds standards of:
CGA G-4.1, ASTM G93, SAE ARP117

Call Maxpro Technologies to receive a quotation regarding cleaning for oxygen service.



HIGH PRESSURE DATA LOGGER/CONTROLLER

Maxpro Technologies introduces an electronic pressure logger to simplify the recording of testing data.

The unit is designed to digitally record pressure during tests, complementing Maxpro pump and booster packaged power systems as well as other types of power systems.

- Pressure loggers are useful in any industry that has need for an easy, accurate way to record pressure tests.
- The complete Pressure Logger comes with a pressure transducer, 2 pre-formatted jump drives and instructions, including step by step instructions on how to create customized test reports.



Pressure Logger Features:

- 7" Color touch screen
- Instant Test Report
- Customerizable Comment and Title Fields
- Trend Pan and Zoom
- Trend Watchline
- USB 2.0 Port
- Ethernet Port
- AC Power: 115/230 V 50/60 Hz
- Digital Indication of Realtime Pressure and Peak Pressure
- Live On-Screen Trending with Watchline
- Data Storage for import into Spreadsheets
- Auto Peak Reset
- Pressure ranges available from 0-100 psi to 0-100,000 psi
- Network Print Server Software included

Options Available:

Keyboard with Touchpad
 Thermocouple and RTD Temperature Sensors
 Multiple Sensors for different Pressure Ranges

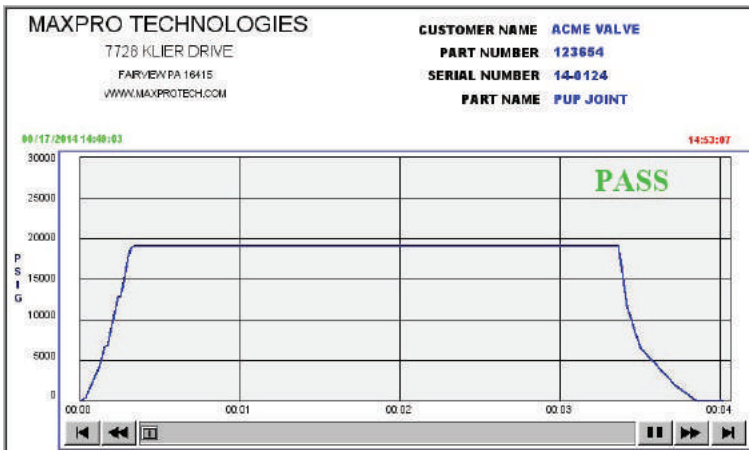

Dimensions	
Maxpro Pressure Logger:	
Height	10"
Width	12"
Depth	8"
Weight	12 lb.



7728 Klier Drive South Fairview, PA 16415
 Phone: 814-474-9191 Fax: 814-474-9391
 Web Site: www.maxprotech.com
 E-mail: sales@maxprotech.com

AIR DRIVEN GAS BOOSTERS, LIQUID PUMPS, AIR AMPLIFIERS AND HIGH PRESSURE VALVES, FITTINGS & TUBING

Maxpro Data Logger/Pump Controller

MAXPRO® Technologies introduces a pump control feature for our Data Logger to provide a quick and easy way to control pump operation. The unit is designed to digitally record pressure during tests, complementing Maxpro pump and booster packaged power systems. Pressure loggers are useful in any industry that needs an easy, accurate way to record pressure tests. Options for multiple channels, temperature flow, and other data are available. Now it is also programmable to provide basic pump operation control.

The standard Pressure Logger comes with a pressure transducer, two pre-formatted jump drives and an operating booklet, including step-by-step instructions on how to create customized test reports on your computer.

*****NEW***** Optional rechargeable battery to allow total independent, on-site use and power back up

Pressure Logger Features:

7" Color Touch Screen

Instant Test Report

- Customizable
- Trend Pan & Zoom
- Trend Watchline

USB 2.0 Port

Ethernet Port

AC Power: 115/230 V 50/60 Hz

Digital Indication of Realtime Pressure & Peak Pressure

Live On-Screen Trending with Watchline

Data Storage for Import into Spreadsheets

Auto Peak Reset

Pressure ranges available from 0-500 psi to 0-100,000 psi

Network Print Server Software included

Dimensions: 10" H x 18" W x 8" D, 15 Lbs Weight

Pump Controller Features:

Programmable air driven pump control

Virtually unlimited number of recipes specifying:

- Pump Ratio
- Up to five steps/ramps of pressure rise
- Maximum pressure not to exceed
- Setpoint program
 - Hold Pressure
 - Stabilization Time
 - Hold Time
 - Hold Mode
 - Maintain Pressure/Allow Decay

Pneumatic Specifications:

- Air Input: 145 psi maximum
- Air Output: 0-130 psi @ 140 SCFM Max
- Connections: 1/2" NPT
- Inlet Filtration: 40 microns

Available Options: Keyboard with Touchpad; Rechargeable Battery Pack (120 VAC operation remains primary); Thermocouple with RTD Temperature Sensors; Multiple Sensors for different pressure ranges

