

# Air Amplifiers & SYSTEMS

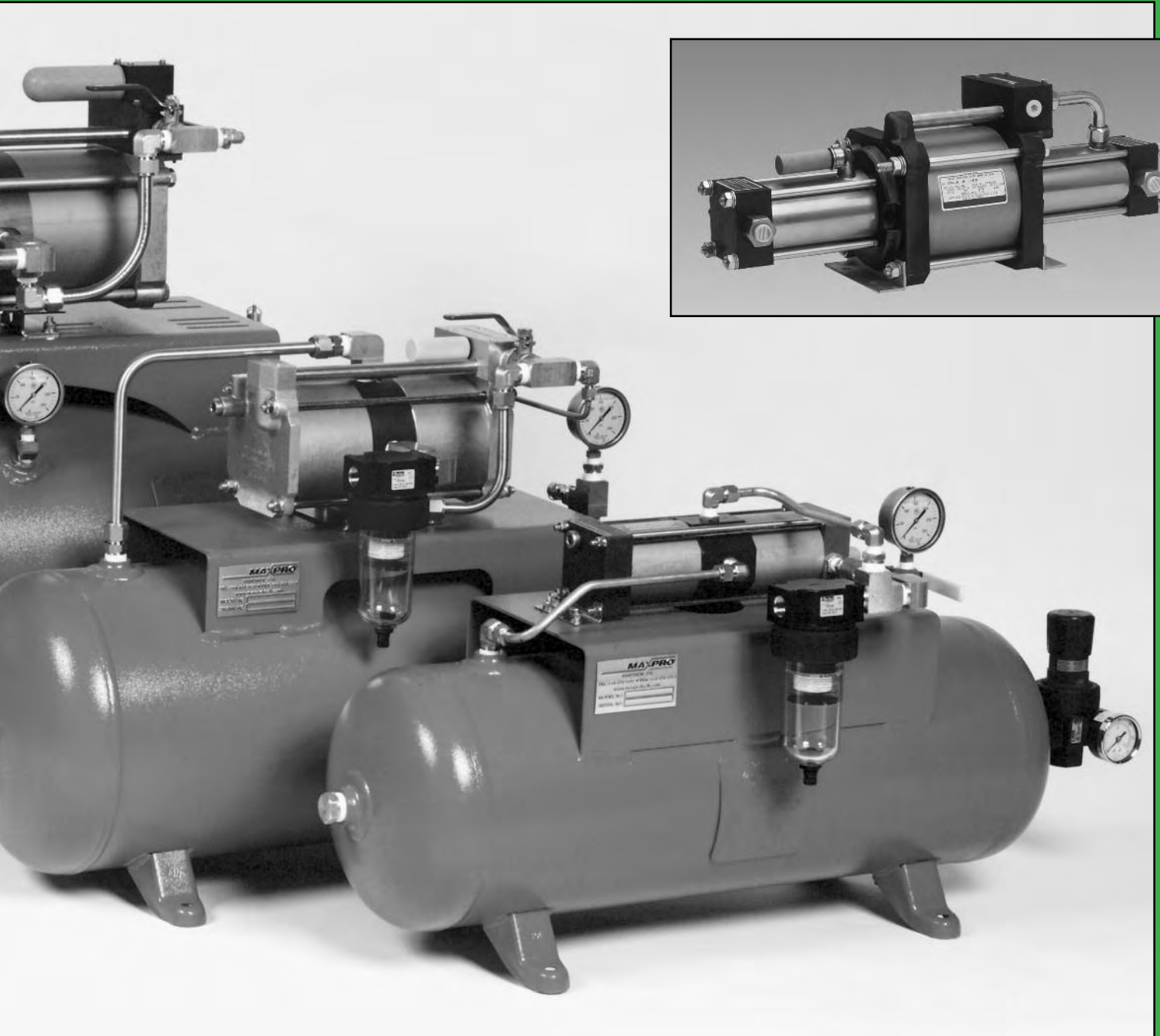

---

# Air Amplifiers

## *Point-of-Use Air Solutions*

**Maximator**® air amplifiers are designed to boost plant air pressure or increase the supply air pressure at work stations and pneumatically operated machinery when the available working pressure is insufficient. Air operated tools become more efficient when coupled with air amplifiers. These amplifiers are capable of generating pressures from 30 psi to 4,350 psi.

Air amplifiers do not need electrical power, since they use the same compressed air source for both driving and amplifying. This ensures quick installation and cost effective operation.

Air amplifiers can be controlled to automatically stop once the desired end pressure has been reached. **The amplifier will restart when a drop of only 1% from the stall pressure has been detected.**

Single stage – **single acting** and single stage – **double acting** air amplifiers are available to satisfy most pressure and flow demands. Amplifiers are ideal for intermittent pressure requirements.

HPT offers complete **turn-key systems** for easy installation. In addition, technical application and service support is available for all air amplifiers and turn-key systems.

## Features

- Air pressures from 30 psi to 4,350 psi
- Compact, lightweight design
- Easy installation and operation
- Single or double acting
- No electrical power required
- “Stall” at target pressure, automatic restart after a drop of only 1% from target pressure
- PTFE SEALS
- Unregulated pilot air port for easy restart and better control on all DLA, SPLV2 and GPLV2 models (1/8" FNPT)
- Standard and custom application designed systems

## Applications

- Boost insufficient shop air or supply air
- Work benches and equipment with limited space
- High pressure air cleaning of weld areas
- Drive pneumatic cylinders
- Improve efficiency of pneumatic tools and machinery
- Boost air for part removal, valve gates and/or automation equipment for injection molding

## Index

How an Air Amplifier Works	3
Technical Information	3
Overall Dimensions	3
Single Stage - Single Acting	4-5
How to Use Curves	5
Single Stage - Double Acting	6-7
Air Amplifier Systems	8-10
Custom Air Amplifier Systems	11
Accessories	11
Dry Air Spool	11

# How an Air Amplifier works

Air Amplifiers are intended for use in boosting existing plant air to higher pressures. Each amplifier has a spool valve that acts like a 4-way directional control valve. Plant air is supplied to this spool valve which automatically cycles back and forth. The plant air that is fed into the spool valve is alternately directed, as the spool cycles, to the main air drive piston in the air drive cylinder. This causes the piston to cycle back and forth in the amplifier.

There is also a high pressure section where the air, that is to be pressurized, is supplied. The air flows into the amplifier pressure chamber, through the inlet check valve(s), on the suction stroke and is pressed out of the chamber, through the outlet check valve(s), on the discharge stroke. The reciprocating movement of the air drive section, connected directly to the high pressure section, creates a positive displacement of air through the inlet and outlet check valves.

There are single and double acting models available. The single acting amplifiers displace air once per full cycle. The double acting amplifiers displace air every stroke, or twice per full cycle, providing higher and more constant flows.

These amplifiers can be installed in any position, but vertical mounting is best for longest seal life.

All connections to the amplifier must be run with equal to, or greater than, the connection size in the amplifier.

**NOTE:**

The air to the amplifier should be filtered to between 5µ and 40µ and have a dew point between 0°F and 50°F. Very moist air can wash out the seal lubricant and very dry air may require a lubricator.

## TECHNICAL INFORMATION

STYLE	CATALOG NUMBER	PRESSURE RATIO	COMPRESSION RATIO	SUPPLY PRESSURE (PSI)		MAX. RATED PRESSURE (PSI)	STALL PRESSURE	CONNECTIONS		MAX. TEMP. F	WEIGHT (LBS.)
				MIN.	MAX.			INLET	OUTLET		
SINGLE ACTING	MPLV4-1	4:1	—	30	Pa	580	4Pa	3/8	3/8	140	7
	DLA5-1	5:1	15:1	30	725	725	5Pa	3/8	3/8	140	35
	DLA15-1	15:1	20:1	100	2175	2175	15Pa	1/4	1/4	210	35
	DLA30-1	30:1	20:1	100	4350	4350	30Pa	9/16-18	9/16-18	210	35
DOUBLE ACTING	MPLV2	2:1	—	15	150	300	Pa + Ps	1/4	1/4	180	12
	SPLV2	2:1	—	15	150	300	Pa + Ps	3/8	3/8	180	18
	GPLV2	2:1	—	25	150	300	Pa + Ps	3/8	3/8	180	45
	DLA5	5:1	15:1	30	1450	1450	5Pa + Ps	3/8	3/8	140	48
	DLA15	15:1	20:1	100	4350	4350	15Pa + Ps	1/4	1/4	210	48

**NOTE:** Pa = Air Drive Pressure (PSI) Ps = Supply Pressure (PSI)

Maximum air drive pressure 145 psi

Maximum operating and stall pressures must not be allowed to exceed output pressure rating.

The 9/16-18 is a 1/4" O.D. tubing, high pressure coned and threaded connection, all other connections are FNPT.

Air drive inlet connection on MPLV4-1 and MPLV2 is 1/4" FNPT.

Air drive inlet connection on **all other** air amplifiers is 1/2" FNPT.

There is a 1/8" FNPT pilot port on all amplifiers, except MPLV4-1 and MPLV2, that must be plumbed from air source.

MOUNTING DIMENSIONS FOR AMPLIFIERS MPLV4-1, DLA5-1, DLA15-1, DLA30-1, MPLV2, DLA5 AND DLA15

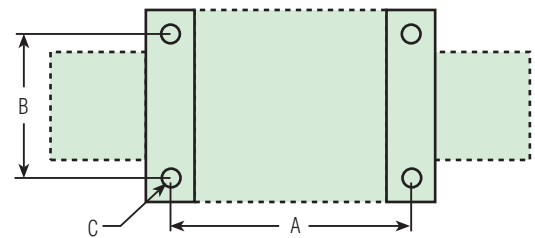

MPLV2, SPLV2 AND GPLV2

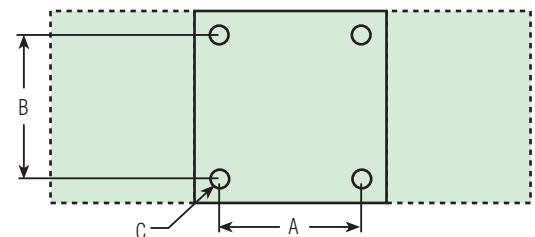

## OVERALL DIMENSIONS (Inches)

CATALOG NUMBER	LENGTH	WIDTH	HEIGHT	MOUNTING		
				A	B	C
MPLV4-1	8.75	3.94	3.34	6.81	2.00	0.38
DLA5-1	16.63	6.75	10.75	9.00	3.13	0.44
DLA15-1	17.00	6.75	10.75	9.00	3.13	0.44
DLA30-1	17.00	6.75	10.75	9.00	3.13	0.44
MPLV2	13.38	3.25	3.50	12.81	2.00	0.38
SPLV2	12.75	5.75	8.00	3.75	4.97	0.38
GPLV2	17.00	8.00	11.00	3.75	7.13	0.38
DLA5	24.00	9.00	9.00	9.00	3.13	0.44
DLA15	24.25	9.00	9.00	9.00	3.13	0.44

# MAXIMATOR® AIR AMPLIFIERS

## SINGLE STAGE SINGLE ACTING

HPT offers four air amplifier models in a single stage – single acting configuration. Single acting models include the MPLV 4-1, DLA 5-1, DLA 15-1 and DLA 30-1. These units provide high pressure air amplification, up to 4,600 psi.

Maximator air amplifiers are compact and lightweight for easy installation and operation. The miniature MPLV 4-1 is approximately 7" high and 3" square and is ideal for light duty and boosting air in tight spaces such as work benches or pneumatic machinery. The DLA5-1, DLA15-1 and DLA30-1 are ideal for industrial applications.

### MPLV4-1

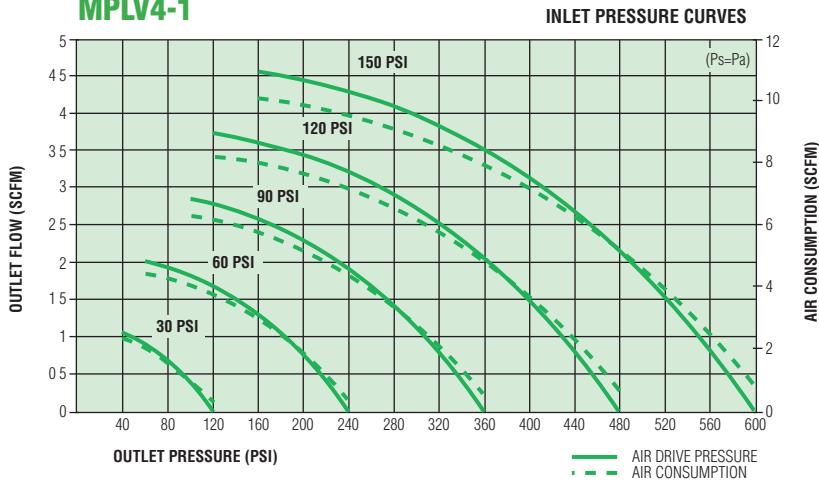

**LIGHT DUTY NON-PRODUCTION USE ONLY**

### DLA5-1

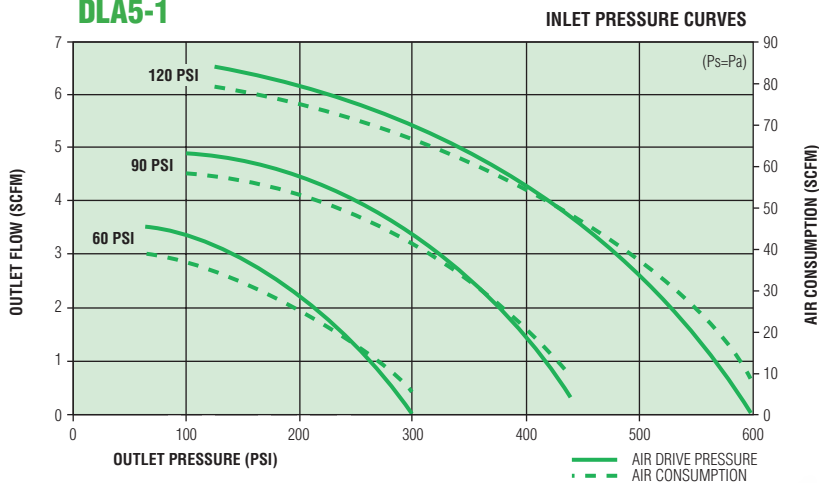

# How to Use Curves

To find output flow rate from graphs below, locate desired outlet pressure on bottom axis. Move vertically from that point until you intersect the solid curve for the inlet air pressure you have available. At this point, move horizontally to the left axis. That point is the value of the outlet flow rate. To obtain the air consumption value to drive the amplifier, move vertically up from the desired outlet pressure until you intersect the dashed curve for the inlet air pressure available. From this point move horizontally to the right axis. That point is the air consumed. The total air flow required to the amplifier is the sum of the outlet flow plus the air drive flow.

# SINGLE STAGE SINGLE ACTING

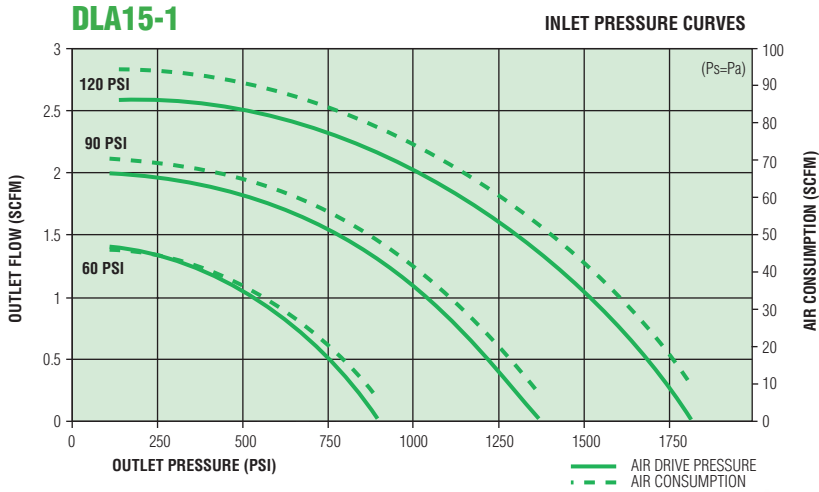

**DLA15-1 & DLA30-1**

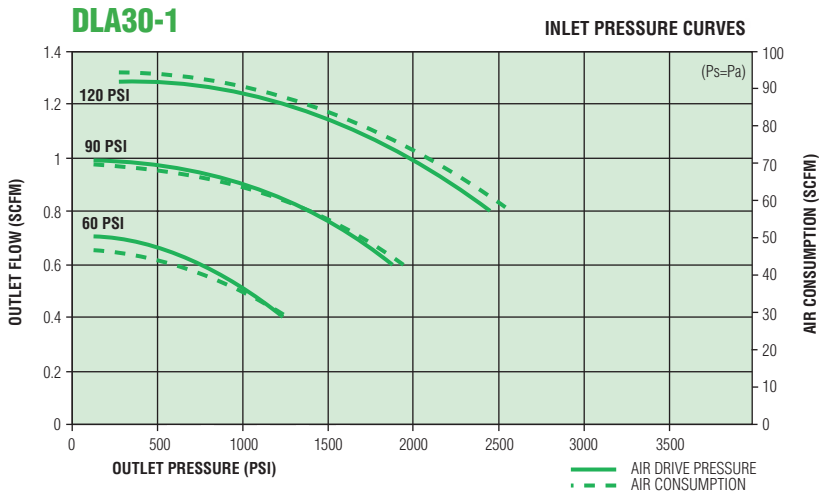

# MAXIMATOR® AIR AMPLIFIERS

## SINGLE STAGE DOUBLE ACTING

For applications demanding a high flow rate as well as increased air pressure, HPT offers single stage – double acting air amplifiers. Double acting models include the MPLV2, SPLV2, GPLV2, DLA5 and DLA15. These air amplifiers are a safe and efficient solution to insufficient air pressures at work stations. The GPLV2 can deliver twice the amount of supply pressure, up to 300 psi, with flow rates up to 125 SCFM.

### MPLV2

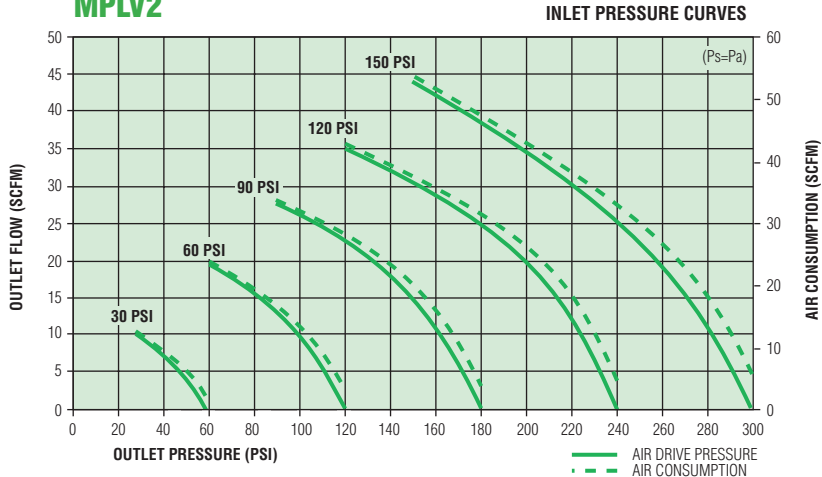

### SPLV2

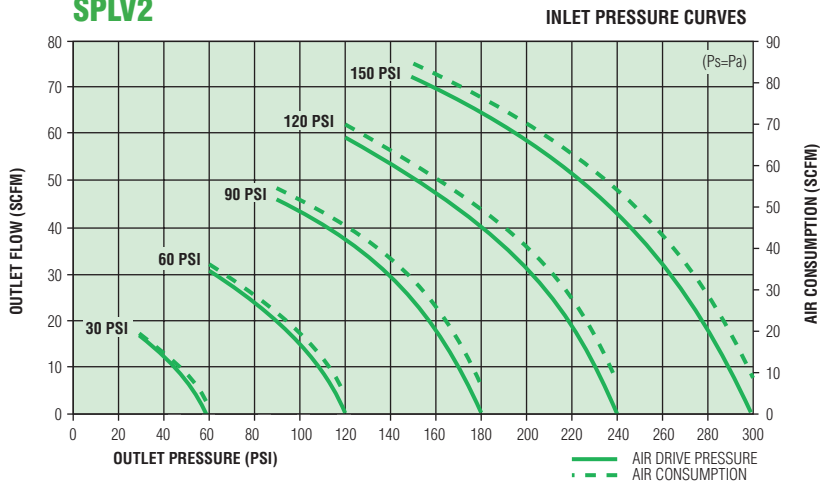

### GPLV2

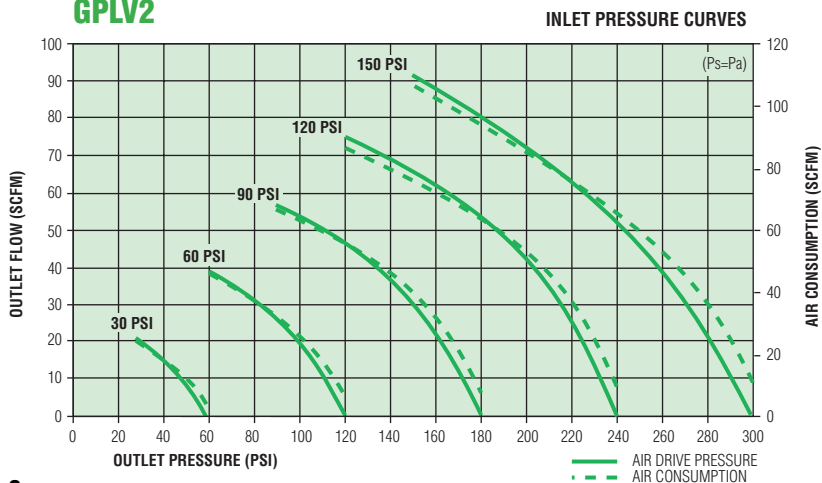

# How to Use Curves

To find output flow rate from graphs below, locate desired outlet pressure on bottom axis. Move vertically from that point until you intersect the solid curve for the inlet air pressure you have available. At this point, move horizontally to the left axis. That point is the value of the outlet flow rate. To obtain the air consumption value to drive the amplifier, move vertically up from the desired outlet pressure until you intersect the dashed curve for the inlet air pressure available. From this point move horizontally to the right axis. That point is the air consumed. The total air flow required to the amplifier is the sum of the outlet flow plus the air drive flow.

# SINGLE STAGE DOUBLE ACTING

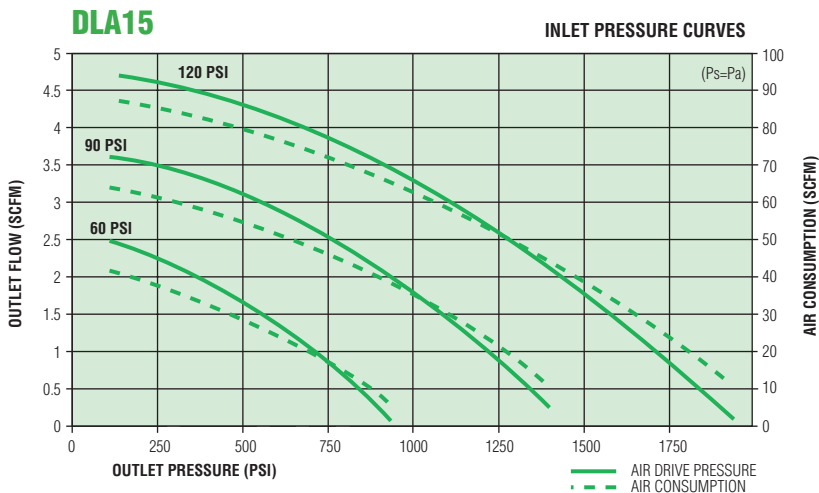
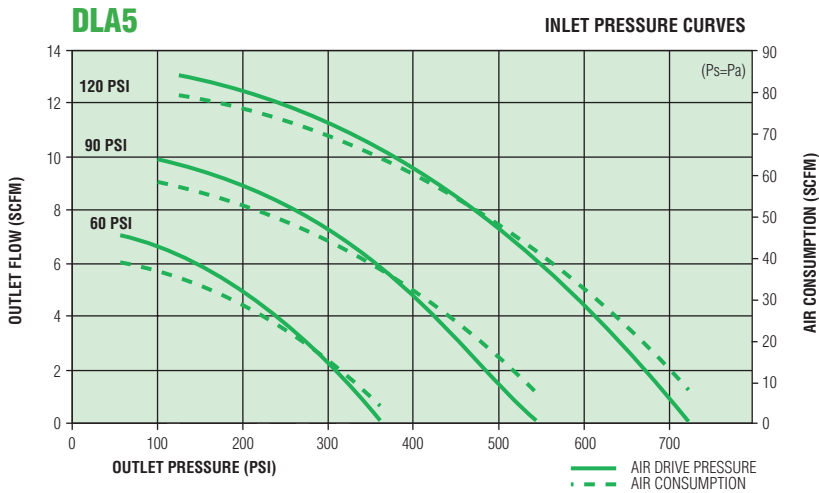

# Air Amplifier Systems

HPTAir Amplifier Systems are ideal for turn-key installation at work stations or machine centers to boost plant air pressure for tools or operation of pneumatic clamps, cylinders and other equipment. These systems provide short-term high flow air or constant flow with reserve, at a constant regulated output pressure. Storage tank is per A.S.M.E. Code and CRN (Canada) and comes with a safety relief valve, drain valve and pressure gauge.

Each 200 psi and 250 psi system is also equipped with an inlet air filter and outlet pressure regulator with gauge, all mounted on a common base. The 500 psi and 600 psi systems are equipped with an inlet air filter and inlet air pressure regulator with gauge. High pressure outlet regulator with gauge is available as an option (Add "-R" for a 1/4" FNPT regulator or "-1/2 R" for a 1/2" FNPT high flow regulator to system catalog number). HPT Air Amplifier Systems are available in a number of arrangements and custom designed units are also available to suit your specific flow and pressure requirements. Please consult factory.

## TECHNICAL DATA

SYSTEM CATALOG NUMBER	AIR AMPLIFIER TYPE	TANK SIZE (GAL.)	SYSTEM RATING (PSI)	CONNECTIONS		OVERALL SIZE (IN.)	WEIGHT (LBS.)	MOUNTING DIMENSIONS (IN.)
				INLET (FNPT)	OUTLET (FNPT)			
<b>2:1 Ratio Systems</b>								
AS-MPLV2-1G	MPLV2	1.6	250	½	½	13L X 8W X 22H	60	7.13 X 9.00 X 0.38
AS-MPLV2-4G	MPLV2	4	250	½	½	22L X 15W X 18H	72	5.00 X 12.25 X 0.44
AS-MPLV2-10GH	MPLV2	10	200	½	½	36L X 14W X 18H	63	9.25 X 18.00 X 0.44
AS-SPLV2-4G	SPLV2	4	250	½	½	22L X 16W X 22H	78	5.00 X 12.25 X 0.44
AS-SPLV2-10GH	SPLV2	10	200	½	½	36L X 14W X 22H	71	9.25 X 18.00 X 0.44
AS-SPLV2-15GH	SPLV2	15	200	½	½	39L X 14W X 24H	86	11.00 X 20.00 X 0.44
AS-GPLV2-4G	GPLV2	4	250	½	½	22L X 20W X 26H	110	5.00 X 12.25 X 0.44
AS-GPLV2-15GH	GPLV2	15	200	½	½	39L X 15W X 26H	113	11.00 X 20.00 X 0.44
AS-GPLV2-30GH	GPLV2	30	200	½	½	44L X 17W X 32H	165	12.81 X 20.00 X 0.44
AS-2GPLV2-15GH	(2) GPLV2	15	200	(2) ½	½	39L X 18W X 26H	165	11.00 X 20.00 X 0.44
AS-2GPLV2-30GH	(2) GPLV2	30	200	(2) ½	½	44L X 18W X 32H	215	12.81 X 20.00 X 0.44
<b>Multiple Ratio Systems</b>								
AS-DLA5-15GH-200	DLA5	15	200	½	½	39L X 15W X 26H	118	11.00 X 20.00 X 0.44
AS-DLA5-30GH-200	DLA5	30	200	½	½	44L X 17W X 32H	170	12.81 X 20.00 X 0.44
AS-DLA5-4G	DLA5	4	500	½	½	20L X 26W X 26H	115	5.00 X 12.25 X 0.44
AS-DLA5-15G	DLA5	15	500	½	½	30L X 19W X 36H	150	9.50 X 22.00 X 0.38

**NOTE:**

See curves for flow rates of appropriate Air Amplifiers on previous pages.

Dimensions are approximate and subject to change. Consult factory.

A standard Air Amplifier System is piped with one common inlet for both air drive and air suction.



## 2:1 Ratio Systems

- AS-MPLV2-1G
- AS-MPLV2-4G
- AS-MPLV2-10GH
- AS-SPLV2-4G
- AS-SPLV2-10GH
- AS-SPLV2-15GH
- AS-GPLV2-4G
- AS-GPLV2-15GH
- AS-GPLV2-30GH



**AS-MPLV2-1G**



**AS-MPLV2-4G**



**AS-MPLV2-10GH**



**AS-SPLV2-4G**

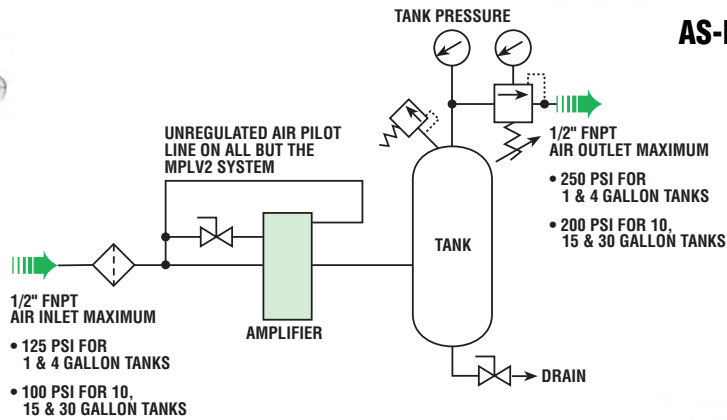

**AS-SPLV2-10GH**  
**AS-SPLV2-15GH**



**AS-GPLV2-4G**



**AS-GPLV2-15GH**  
**AS-GPLV2-30GH**

# AIR AMPLIFIER SYSTEMS

## Multiple Ratio Systems

AS-DLA5-15GH-200  
AS-DLA5-30GH-200

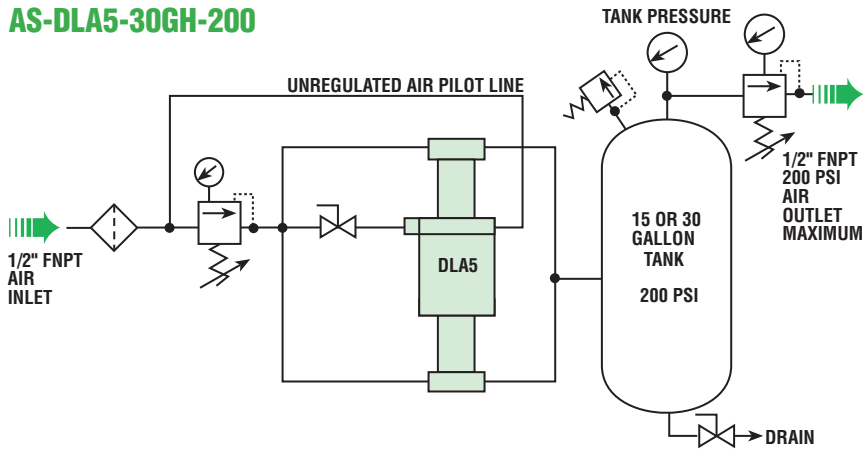

AS-DLA5-15GH-200  
AS-DLA5-30GH-200

## Multiple Ratio Systems

AS-DLA5-4G  
AS-DLA5-15G

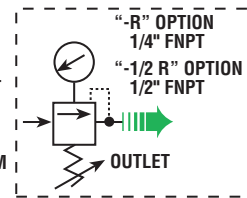
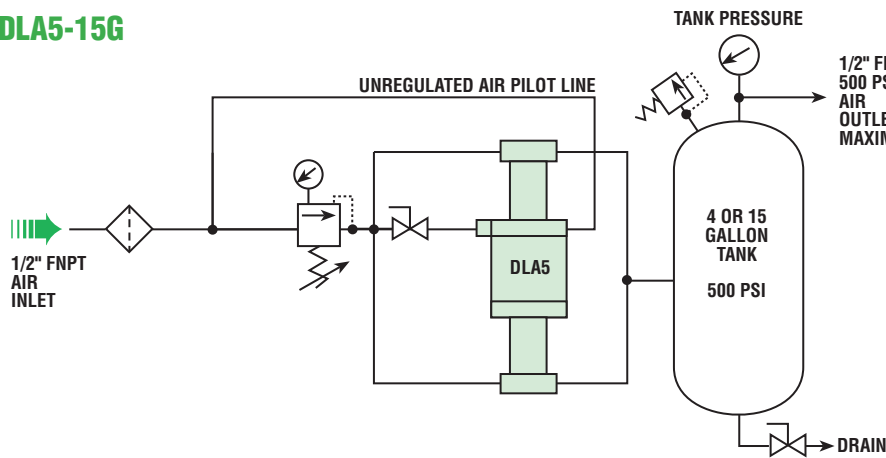

AS-DLA5-4G



AS-DLA5-15G-R

## Custom Air Amplifier Systems

HPT custom air amplifier systems are designed to suit your specific flow and pressure requirements. As with all custom systems, the design may incorporate a number of options unique to your application. Specifications may include overall size, inlet or outlet size, air amplifier type, tank size and psi rating. Custom systems are capable of generating pressures from 30 psi to 4,350 psi.

HPT custom air amplifier systems are ideal for boosting pressure to pneumatic tools, clamps and cylinders. These systems will also maintain elevated pressures to machinery and test equipment, and provide high pressure air for robotics and injection molding. Please consult factory.



**HIGH PRESSURE DUAL TANK SYSTEM**



**200 GALLON AMPLIFIER SYSTEM**



**DUAL AMPLIFIER SYSTEM**



**ENVIRONMENTALLY SEALED AMPLIFIER PACKAGED**



**MULTIPLE OUTLET SYSTEM**

## Accessories

All HPT air amplifiers are available with an optional air control unit – ACP (except for the MPLV2 which uses a – ACM). This package is shown to the right and consists of an air filter, regulator with gauge, shut-off valve and necessary fittings and hose for plumbing the unregulated pilot port on all DLA, SPLV2 and GPLV2 models.

HPT offers a wide variety of other accessories to assist the installation of your Air Amplifier, such as strainers, filters, receiver/tanks, gauges, valves and fittings.



**AIR CONTROL PACKAGE – ACP**

## Dry Air Spool

### For severe duty service

In applications where very dry air or nitrogen is used to drive Maximator pumps or boosters there is a **new spool seal option** available to provide longer duty between maintenance.

This **Dry Air Spool (DAS)** option should be considered for extreme operating conditions involving air or gas drive mediums below 0°F. dewpoint, and similarly, very cold climate applications (-40°C.).

This new design can be retrofitted to existing pumps and boosters as it only involves the spool, spool sleeve, and seals. The spool block remains the same. Be sure to use an appropriate tool to pull the spool sleeve! Minimum air drive with this option is 30 psig.

To order with a pump simply add – DAS to model number. To retrofit to an existing pump, order “Dry Air Spool” and specify the pump model and serial number.



## OTHER PRODUCTS

### Valves, Fittings & Tubing

- Highest quality for superior product performance
- Standard metals of stainless steel
- Pressures to 152,000 PSI



### Liquid Pumps

- Air driven to 60,000 psi
- Economic hydraulic power
- Interchangeable with other leading pumps
- Requires no electrical power
- Variety of sizes and styles to suit your application



### Gas Boosters

- Air driven to 21,750 psi
- Ideal for gas salvage
- Requires no lubrication or electrical power
- Unit is contaminant free
- For use with a variety of gases



### Packaged Systems

- Air Amplifier System for boosting shop air
- Gas Booster System for gas reclaim and bottle filling
- Hydraulic Power Unit
- Hydraulic Test Stands for pressure testing



### Repair Service Available

- Guaranteed quality workmanship
- Cost effective quick turnaround
- Use original manufacture parts
- Factory support



All technical and dimensional information subject to change.

All general terms and conditions of sale, including limitations of our liability, apply to all products and services sold.