

# High Pressure Valves, Fittings and Tubing

## Pressures to 65,000 psi

**MAXIMATOR** has been designing and manufacturing high pressure equipment for more than thirty years and has a worldwide reputation for quality and reliability, backed by one of the best service organizations in the industry.

### High Pressure Valves feature:

- ▶ Rising stem design.
- ▶ 316SS wetted parts with a 17-4 PH stem provides excellent corrosion resistance.
- ▶ Metal-to-metal seating achieves bubble-tight shut-off, longer stem and seat life, greater durability for repeated open and close cycles.
- ▶ PTFE and carbon packing with metal back-up rings offers reliable stem to body sealing.
- ▶ Non-rotating stem prevents stem to seat galling.
- ▶ Stem sleeve and packing gland materials have been selected to achieve optimum thread cycle life and reduced handle torque. All stem sleeve threads are rolled, assuring smooth operation.
- ▶ Safety weep holes for all pressure connections and packing area.
- ▶ Six different valve body patterns, with choice of vee or regulating type stem tip.

**MAXPRO** offers a complete line of high pressure fittings, tubing, check valves, line filters, anti-vibration fittings and safety head assemblies. All high pressure valves and fittings use the high pressure style connection.

**Note:** When selecting multiple items, the pressure rating would be that of the lowest rated component.

### High Pressure Index

Valves rated to 36,000 psi .....	2-3
Valves rated to 65,000 psi .....	4-5
Fittings .....	6
Anti-Vibration Collet Gland Assemblies .....	7
Tubing .....	8
Coned and Threaded Nipples .....	9
Check Valves .....	10
Line Filters .....	11
Angle Filters .....	12
Safety Head Assemblies and Rupture Discs .....	13

**Maxpro Technologies, Inc.**  
 7728 Klier Drive South · Fairview Pennsylvania 16415  
 Phone: 814-474-9191 · Fax: 814-474-9391  
 website: www.maxprotech.com

All general terms and conditions of sale, including limitations of our liability, apply to all products and services sold.  
 MT R4 0215



Printed in the USA

# High Pressure Valves

## Pressures to 36,000 psi



### Ordering Information

Typical catalog number: **36V4H071**

36V	4H	07	1	OPTIONS
Valve Series	O.D. Tube Size	Stem Type	Body Pattern	Extreme temperature option, see below.
36V	4H - 1/4" 6H - 3/8" 9H - 9/16"	07 - VEE stem 08 - regulating stem (tapered tip for regulating and shutoff) 87 - VEE stem with replaceable seat 88 - regulating stem with replaceable seat	1 - two-way straight 2 - two-way angle 3 - three-way, two on pressure 4 - three-way, one on pressure 5 - three-way, two-stem manifold	

### Special Designs for Extreme Temperatures

Standard valves are supplied with Teflon/Carbon packing and may be operated to 450°F. High temperature packing and/or extended stuffing box are available for service from -423°F to 1200°F by adding the following suffixes to catalog order number.

- **TG** standard valve with teflon glass packing to 600°F.
- **GY** standard valve with graphite braided yarn packing to 800°F.
- **HT** extended stuffing box valve with graphite braided yarn packing to 1200°F.
- **B** standard valve with cryogenic trim materials and teflon packing to -100°F.
- **LT** extended stuffing box valve with teflon packing and cryogenic trim materials to -423°F.

### Repair Kits

Consult your **MAXPRO** representative for repair kits and valve bodies. Refer to the Tools and Installation section for proper maintenance procedures.

**MAXIMATOR** high pressure valves with metal to metal seats have a high level of safety and reliability under adverse operating conditions. These valves may be used both with gases and liquids.

Traceability is ensured through extensively documented data (batch number, max. pressure, material number, type designation). All high pressure valves include glands and collars.

O.D. Size (in.)	Connection Type	Orifice Size (in.)	Rated Cv*	Pressure/Temp. Rating (psi @ R.T.)**
1/4	4HF	0.094	0.12	36,000
3/8	6HF	0.125	0.23	36,000
9/16	9HF	0.125	0.33	36,000

\* Cv values shown are for 2-way straight pattern vee stem valves.

For 2-way angle patterns, increase the Cv value by 50%.

\*\* See page 2 in the Technical Section for Pressure/Temperature Rating Chart.

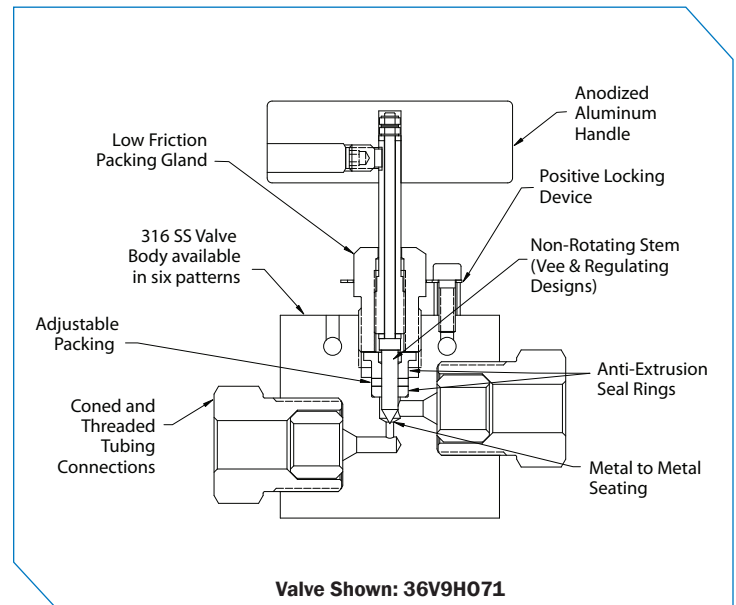
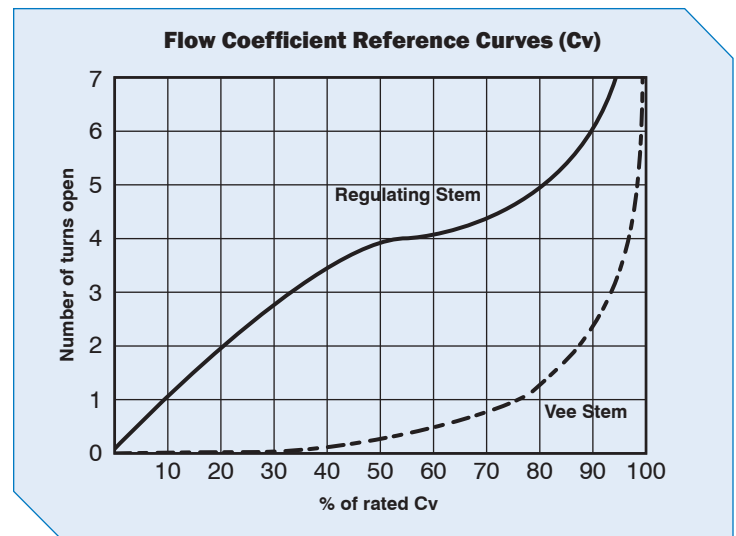

Valve Shown: **36V9H071**

All general terms and conditions of sale, including limitations of our liability, apply to all products and services sold.  
MT R4 0215

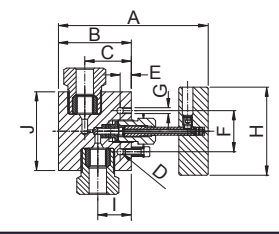
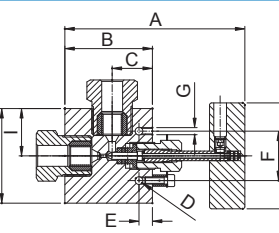
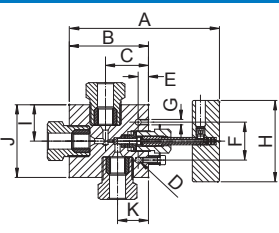
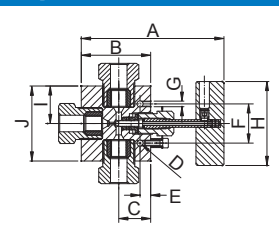
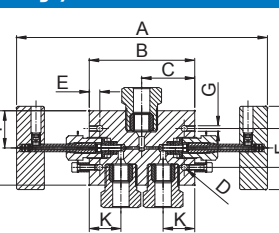
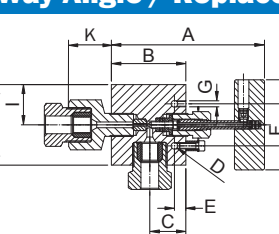
Valve Pattern	Catalog Number	Stem Type	O.D. Tube (in.)	Orifice (in.)	Dimensions (in.)										Valve Panel Hole	Block Thickness
					A	B	C	D	E	F	H	I	J	K		
<b>2-Way Straight</b>																
	36V4H071	Vee	1/4	0.094	4.96	2.01	1.50	0.22	0.37	1.38	2.95	1.12	2.01		1.00	1.02
	36V4H081	Reg														
	36V6H071	Vee	3/8	0.125	4.96	2.01	1.50	0.22	0.37	1.38	2.95	1.12	2.01		1.00	1.02
	36V6H081	Reg														
	36V9H071	Vee	9/16	0.125	5.00	2.44	1.56	0.22	0.37	1.38	2.95	1.12	2.64		1.00	1.54
	36V9H081	Reg														
<b>2-Way Angle</b>																
	36V4H072	Vee	1/4	0.094	4.96	2.01	1.12	0.22	0.37	1.38	2.95	1.00	2.01		1.00	1.02
	36V4H082	Reg														
	36V6H072	Vee	3/8	0.125	4.78	2.20	1.10	0.22	0.37	1.38	2.95	1.00	2.01		1.00	1.02
	36V6H082	Reg														
	36V9H072	Vee	9/16	0.125	5.00	2.44	1.12	0.22	0.37	1.38	2.95	1.32	2.64		1.00	1.54
	36V9H082	Reg														
<b>3-Way / 2 on Pressure</b>																
	36V4H073	Vee	1/4	0.094	4.69	2.13	1.50	0.22	0.37	1.38	2.95	1.00	2.01	1.12	1.00	1.02
	36V4H083	Reg														
	36V6H073	Vee	3/8	0.125	5.08	2.50	1.50	0.22	0.37	1.38	2.95	1.00	2.01	1.12	1.00	1.02
	36V6H083	Reg														
	36V9H073	Vee	9/16	0.125	5.45	2.87	1.56	0.22	0.37	1.38	2.95	1.32	2.64	1.12	1.00	1.54
	36V9H083	Reg														
<b>3-Way / 1 on Pressure</b>																
	36V4H074	Vee	1/4	0.094	4.96	2.01	1.12	0.22	0.37	1.38	2.95	1.00	2.01		1.00	1.02
	36V4H084	Reg														
	36V6H074	Vee	3/8	0.125	4.76	2.20	1.12	0.22	0.37	1.38	2.95	1.00	2.01		1.00	1.02
	36V6H084	Reg														
	36V9H074	Vee	9/16	0.125	5.00	2.44	1.12	0.22	0.37	1.38	2.95	1.32	2.64		1.00	1.54
	36V9H084	Reg														
<b>3-Way / 2-Stem Manifold</b>																
	36V4H075	Vee	1/4	0.094	8.23	3.07	1.54	0.22	0.37	1.38	2.95	1.00	2.01	1.12	1.00	1.02
	36V4H085	Reg														
	36V6H075	Vee	3/8	0.125	8.39	3.25	1.61	0.22	0.37	1.38	2.95	1.00	2.01	1.12	1.00	1.02
	36V6H085	Reg														
	36V9H075	Vee	9/16	0.125	8.90	3.74	1.88	0.22	0.37	1.38	2.95	1.32	2.64	1.12	1.00	1.54
	36V9H085	Reg														
<b>2-Way Angle / Replaceable Seat</b>																
	36V4H872	Vee	1/4	0.094	4.96	2.38	1.12	0.22	0.37	1.38	2.95	1.00	2.01	0.90	1.00	1.02
	36V4H882	Reg														
	36V6H872	Vee	3/8	0.125	4.96	2.38	1.12	0.22	0.37	1.38	2.95	1.00	2.01	1.15	1.00	1.02
	36V6H882	Reg														
	36V9H872	Vee	9/16	0.125	5.00	2.44	1.18	0.22	0.37	1.38	2.95	1.32	2.64	1.48	1.00	1.54
	36V9H882	Reg														

G - Panel mounting screw thread size 10-24 UNC.  
All dimensions are for reference only and subject to change.

# High Pressure Valves

Pressures to 65,000 psi

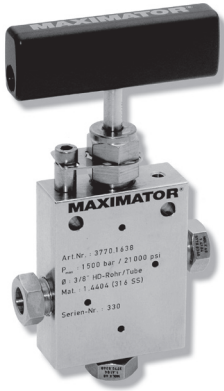

## Ordering Information

Typical catalog number: **65V4H071**

65V	4H	07	1	OPTIONS
Valve Series	O.D. Tube Size	Stem Type	Body Pattern	Extreme temperature option, see below.
65V	4H - 1/4" 6H - 3/8" 9H - 9/16"	07 - VEE stem 08 - regulating stem (tapered tip for regulating and shutoff) 87 - VEE stem with replaceable seat 88 - regulating stem with replaceable seat	1 - two-way straight 2 - two-way angle 3 - three-way, two on pressure 4 - three-way, one on pressure 5 - three-way, two-stem manifold	

## Special Designs for Extreme Temperatures

Standard valves are supplied with Teflon/Carbon packing and may be operated to 450°F. High temperature packing and/or extended stuffing box are available for service from -423°F to 1200°F by adding the following suffixes to catalog order number.

- **TG** standard valve with teflon glass packing to 600°F.
- **GY** standard valve with graphite braided yarn packing to 800°F.
- **HT** extended stuffing box valve with graphite braided yarn packing to 1200°F.
- **B** standard valve with cryogenic trim materials and teflon packing to -100°F.
- **LT** extended stuffing box valve with teflon packing and cryogenic trim materials to -423°F.

## Repair Kits

Consult your **MAXPRO** representative for repair kits and valve bodies. Refer to the Tools and Installation section for proper maintenance procedures.

**MAXIMATOR** high pressure valves with metal to metal seats have a high level of safety and reliability under adverse operating conditions. These valves may be used both with gases and liquids.

Traceability is ensured through extensively documented data (batch number, maximum pressure, material number, type designation). All high pressure valves include glands and collars.

O.D. Size (in.)	Connection Type	Orifice Size (in.)	Rated Cv*	Pressure/Temp. Rating (psi @ R.T.)**
1/4	4HF	0.062	0.08	65,000
3/8	6HF	0.062	0.09	65,000
9/16	9HF	0.078	0.14	65,000

\* Cv values shown are for 2-way straight pattern vee stem valves.  
For 2-way angle patterns, increase the Cv value by 50%.

\*\* See page 2 in the Technical Section for Pressure/Temperature Rating Chart.

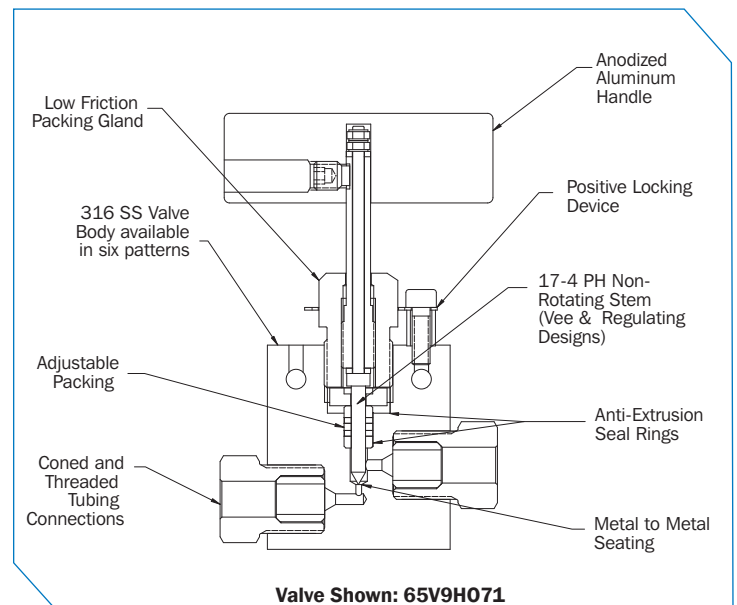
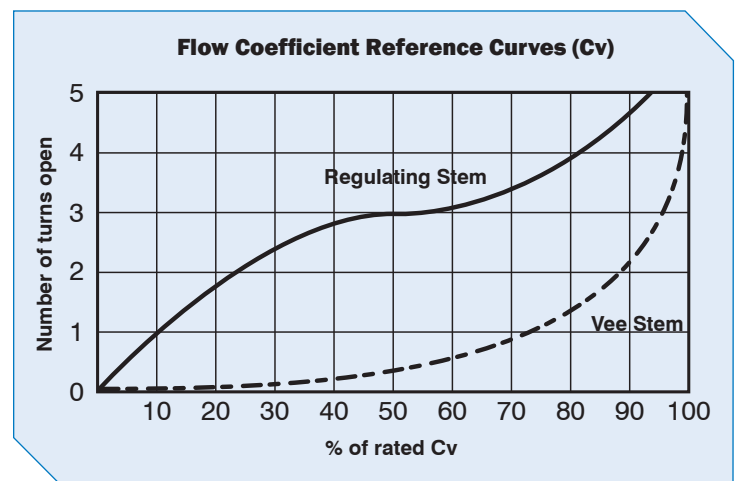

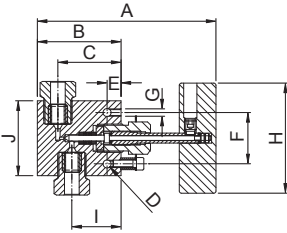
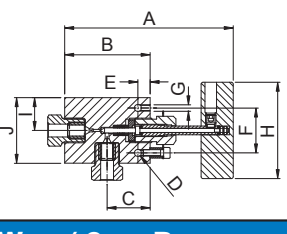
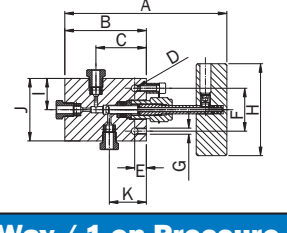
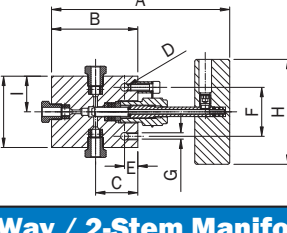
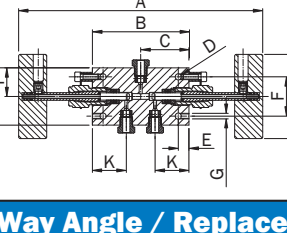
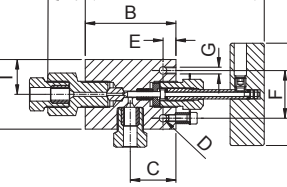
Valve Pattern	Catalog Number	Stem Type	O.D. Tube (in.)	Orifice (in.)	Dimensions (in.)										Valve Panel Hole	Block Thickness
					A	B	C	D	E	F	H	I	J	K		
<b>2-Way Straight</b>																
	65V4H071	Vee	1/4	0.062	4.67	2.13	1.69	0.22	0.37	1.38	2.95	1.32	2.01		1.00	1.02
	65V4H081	Reg														
	65V6H071	Vee	3/8	0.062	4.80	2.24	1.69	0.22	0.37	1.38	2.95	1.32	2.01		1.00	1.02
	65V6H081	Reg														
	65V9H071	Vee	9/16	0.078	5.04	2.50	1.75	0.22	0.37	1.38	2.95	1.30	2.64		1.00	1.54
	65V9H081	Reg														
<b>2-Way Angle</b>																
	65V4H072	Vee	1/4	0.062	4.96	2.38	1.34	0.22	0.37	1.38	2.95	1.00	2.01		1.00	1.02
	65V4H082	Reg														
	65V6H072	Vee	3/8	0.062	5.16	2.62	1.32	0.22	0.37	1.38	2.95	1.00	2.01		1.00	1.02
	65V6H082	Reg														
	65V9H072	Vee	9/16	0.078	5.35	2.80	1.32	0.22	0.37	1.38	2.95	1.32	2.64		1.00	1.54
	65V9H082	Reg														
<b>3-Way / 2 on Pressure</b>																
	65V4H073	Vee	1/4	0.062	4.96	2.38	1.69	0.22	0.37	1.38	2.95	1.00	2.01	1.32	1.00	1.02
	65V4H083	Reg														
	65V6H073	Vee	3/8	0.062	5.31	2.76	1.69	0.22	0.37	1.38	2.95	1.00	2.01	1.32	1.00	1.02
	65V6H083	Reg														
	65V9H073	Vee	9/16	0.078	5.71	3.15	1.75	0.22	0.37	1.38	2.95	1.32	2.64	1.30	1.00	1.54
	65V9H083	Reg														
<b>3-Way / 1 on Pressure</b>																
	65V4H074	Vee	1/4	0.062	4.96	2.38	1.32	0.22	0.37	1.38	2.95	1.00	2.01		1.00	1.02
	65V4H084	Reg														
	65V6H074	Vee	3/8	0.062	5.16	2.62	1.32	0.22	0.37	1.38	2.95	1.00	2.01		1.00	1.02
	65V6H084	Reg														
	65V9H074	Vee	9/16	0.078	5.35	2.80	1.32	0.22	0.37	1.38	2.95	1.32	2.64		1.00	1.54
	65V9H084	Reg														
<b>3-Way / 2-Stem Manifold</b>																
	65V4H075	Vee	1/4	0.062	8.56	3.44	1.72	0.22	0.37	1.38	2.95	1.00	2.01	1.32	1.00	1.02
	65V4H085	Reg														
	65V6H075	Vee	3/8	0.062	8.56	3.76	1.89	0.22	0.37	1.38	2.95	1.00	2.01	1.32	1.00	1.02
	65V6H085	Reg														
	65V9H075	Vee	9/16	0.078	9.25	4.13	2.07	0.22	0.37	1.38	2.95	1.32	2.64	1.30	1.00	1.54
	65V9H085	Reg														
<b>2-Way Angle / Replaceable Seat</b>																
	65V4H872	Vee	1/4	0.062	5.16	2.62	1.32	0.22	0.37	1.38	2.95	1.00	2.01	0.83	1.00	1.02
	65V4H882	Reg														
	65V6H872	Vee	3/8	0.062	5.16	2.62	1.32	0.22	0.37	1.38	2.95	1.00	2.01	1.07	1.00	1.02
	65V6H882	Reg														
	65V9H872	Vee	9/16	0.078	5.16	2.62	1.32	0.22	0.37	1.38	2.95	1.32	2.64	1.47	1.00	1.54
	65V9H882	Reg														

G - Panel Mounting Screw Thread Size 10-24 UNC.  
All dimensions are for reference only and subject to change.

# High Pressure Fittings

Pressures to 65,000 psi



**MAXIMATOR** high pressure fittings are designed to be used with the 36V and 65V series high pressure valves and high pressure tubing. All high pressure fittings have coned and threaded type connections. Mounting holes are standard on all elbows, tees, and crosses.

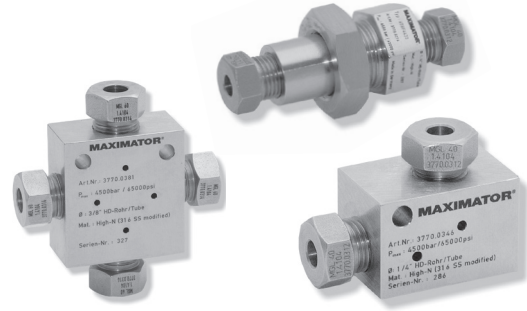

Tubing Size	Gland	Collar	Plug	Tubing Cap
1/4	65G4H	65C4H	65P4H	65TC4H
3/8	65G6H	65C6H	65P6H	65TC6H
9/16	65G9H	65C9H	65P9H	65TC9H

## Connection Components

All high pressure fittings are supplied with glands and collars. Refer to the adjacent chart for ordering any of the connection components individually. When using the plug, the collar is not needed.

Fitting Pattern	Catalog Number	Connection Type	O.D. Tube Size (in.)	Orifice (in.)	Dimensions (in.)							Block Thickness
					A	B	C	D	E	F	G	
<b>Elbow</b>												
	65L4H	4HF	1/4	0.094	0.89	1.02	1.54	0.63	0.46	0.65	0.22	1.02
	65L6H	6HF	3/8	0.125	1.26	1.50	2.01	0.98	0.72	0.69	0.26	1.02
	65L9H	9HF	9/16	0.188	1.89	1.89	2.64	1.10	0.83	0.94	0.33	1.54
<b>Tee</b>												
	65T4H	4HF	1/4	0.094	1.00	1.26	2.01	0.89	0.46	1.30	0.22	1.02
	65T6H	6HF	3/8	0.125	1.00	1.57	2.01	1.06	0.72	1.38	0.26	1.02
	65T9H	9HF	9/16	0.188	1.32	2.13	2.64	1.38	0.83	1.89	0.33	1.54
<b>Cross</b>												
	65X4H	4HF	1/4	0.094	1.00	1.26	2.01	0.63	0.46	1.30	0.22	1.02
	65X6H	6HF	3/8	0.125	1.00	2.13	2.01	1.06	0.72	1.38	0.26	1.02
	65X9H	9HF	9/16	0.188	1.32	2.76	2.64	1.38	0.83	1.89	0.33	1.54
<b>Straight Coupling / Union Coupling</b>												
	65F4H	4HF	1/4	0.094	1.38	1.06	Straight Coupling					
	65UF4H						Union Coupling					
	65F6H	6HF	3/8	0.125	1.77	1.06	Straight Coupling					
	65UF6H						Union Coupling					
	65F9H	9HF	9/16	0.188	2.19	1.44	Straight Coupling					
	65UF9H						Union Coupling					
<b>Bulkhead Coupling</b>												
	65BF4H	4HF	1/4	0.094	1.89	1.06	1.06	0.94	0.25			
	65BF6H	6HF	3/8	0.125	2.38	1.44	1.44	1.18	0.35			
	65BF9H	9HF	9/16	0.188	2.76	1.63	1.63	1.43	0.67			

See page 2 in the Technical Section for pressure/temperature rating chart. All dimensions are for reference only and are subject to change.

All general terms and conditions of sale, including limitations of our liability, apply to all products and services sold. MT R4 0215



**MAXIMATOR** anti-vibration collet gland assemblies are for use in applications where there could be extreme external mechanical vibrations or shock in tubing lines. These collet gland assemblies are interchangeable with the standard high pressure coned and threaded tube connections.

In a normal coned and threaded tube connection, any external mechanical loading on the tubing lines, valves or fittings, would be concentrated on the first thread of the tube. This can cause failure of the tube at this thinner cross-section. The anti-vibration collet gland assembly grips the tube behind the connection, supporting the tube at the full cross-section and straight area, moving the loading away from the threaded area.

The anti-vibration collet gland assembly, when tightened properly, compresses a split collet on the tube, providing the beneficial gripping action.

All anti-vibration collet gland assemblies come with a Molybdenum Disulfide Coating to guard against galling of the stainless components.

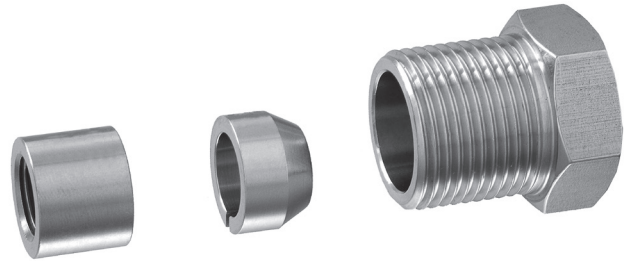

Gland Pattern	Catalog Number	Part	O.D. Tubing Size (in.)	Dimensions (in.)	
				A	B (Hex.)
	<b>65AVA4H</b>	Complete Assembly	1/4	0.83	0.62
	<b>65AVFC4H</b>	Flat Collar			
	<b>65AVC4H</b>	Slotted Collet			
	<b>65AVG4H</b>	Gland Nut			
	<b>65AVA6H</b>	Complete Assembly	3/8	1.16	0.81
	<b>65AVFC6H</b>	Flat Collar			
	<b>65AVC6H</b>	Slotted Collet			
	<b>65AVG6H</b>	Gland Nut			
	<b>65AVA9H</b>	Complete Assembly	9/16	1.50	1.19
	<b>65AVFC9H</b>	Flat Collar			
	<b>65AVC9H</b>	Slotted Collet			
	<b>65AVG9H</b>	Gland Nut			

All dimensions are for reference only and are subject to change.

See page 2 in the Technical Section for determining operating pressures above room temperature.

# High Pressure Tubing

## Pressures to 65,000 psi

**MAXPRO** offers a line of cold drawn thick wall tubing, with flow areas to compliment the high pressure valves and fittings. This tubing is made under strict manufacturing and quality control standards and inspections, with dimensional tolerances to match the requirements of the high pressure coned and threaded connections.

The standard materials are 304 and 316 stainless steels. Other materials may be provided on special request, depending on the specific material, diameters and lengths.

**MAXPRO** also offers this tubing with the “Autofrettage” process. Autofrettage is the practice of subjecting the internal bore of the tubing to a pressure sufficiently high enough to plastically deform the bore, resulting in a residual compressive stress once the pressure is released. Autofrettage produces improved fatigue life of the tube, important in waterjet cutting and other production environments, reducing down time.

Add suffix *-AF* to tubing catalog number to specify Autofrettage process.



### Tubing Tolerances

Normal Tubing Size (in.)	Tolerance O.D. (in.)
1/4	0.248 / 0.243
3/8	0.370 / 0.365
9/16	0.557 / 0.552

Catalog Number	Tube Material	Fits Connection Type	Tube Size (in.)		Working Pressure (psi)				
			O.D.	I.D.	-325 to 100°F	200°F	400°F	600°F	800°F
<b>65TU4H-316</b>	316SS	4HF	1/4	0.083	65,000	58,500	53,950	49,400	46,800
<b>65TU4H-304</b>	304SS								
<b>65TU6H-316</b>	316SS	6HF	3/8	0.125	65,000	58,500	53,950	49,400	46,800
<b>65TU6H-304</b>	304SS								
<b>65TU9H-316</b>	316SS	9HF	9/16	0.188	65,000	58,500	53,950	49,400	46,800
<b>65TU9H-304</b>	304SS								

All dimensions are for reference only and are subject to change.





**MAXPRO** offers a line of coned and threaded high pressure tube nipples in a variety of lengths for all standard tube sizes.

The coned and threaded high pressure tube nipples are available in 316 stainless steel. See chart below for ordering information.

Special length coned and threaded nipples are available upon request. Consult **MAXPRO** for availability and price.

Catalog Numbers are 316 Stainless Steel material							Fits Connection Type	Tube Size (in.)		Working Pressure at 100° F (psi)
2.75" Length	3" Length	4" Length	6" Length	8" Length	10" Length	12" Length		O.D.	I.D.	
65N4H-2.75-316	65N4H-3-316	65N4H-4-316	65N4H-6-316	65N4H-8-316	65N4H-10-316	65N4H-12-316	4HF	1/4	0.083	65,000
	65N6H-3-316	65N6H-4-316	65N6H-6-316	65N6H-8-316	65N6H-10-316	65N6H-12-316	6HF	3/8	0.125	65,000
		65N9H-4-316	65N9H-6-316	65N9H-8-316	65N9H-10-316	65N9H-12-316	9HF	9/16	0.188	65,000

Standard nipples are not supplied with glands and collars, see Fittings on page 6 for these components.

See adjacent Tubing page 8, for pressure/temperature rating chart.

All dimensions are for reference only and subject to change.

## O-Ring Check Valves



## O-Ring Check Valves

**MAXIMATOR** o-ring check valves provide high quality directional flow control and tight shutoff for liquids and gases. All check valves are supplied with glands and collars. These check valves are not to be used as a relief device.

### Materials.

Body, cover, poppet, cover gland: 316 series stainless steel  
 Spring: 300 series stainless steel  
 O-ring: Viton "A" (-4 °F to 392 °F)\*

## Ball Check Valves



## Ball Check Valves

**MAXIMATOR** ball check valves prevent reverse flow where bubble tight shutoff is not mandatory. These check valves are designed with a ball cradled floating poppet to assure positive inline seating. This poppet design allows full flow around the ball to minimize pressure drop. Check valves are rated to 660 °F\*. All check valves are supplied with glands and collars. These check valves are not to be used as a relief device.

### Materials.

Body, cover, poppet, cover gland: 316 series stainless steel  
 Ball and spring: 300 series stainless steel

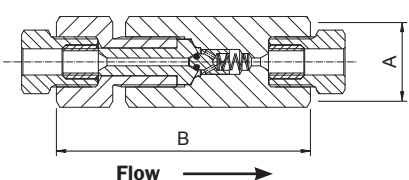
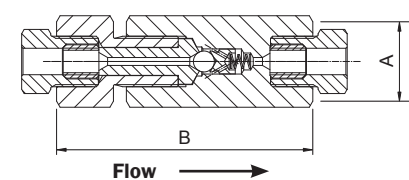
Valve Pattern	Catalog Number	Pressure Rating (psi)	O.D. Tube (in.)	Connection Type	Orifice (in.)	Rated (Cv)	Dimensions (in.)	
							A (Hex.)	B
<b>O-Ring Check Valves</b>								
	<b>650C4H</b>	65,000	1/4	4HF	0.094	0.15	1.19	3.40
	<b>650C6H</b>	65,000	3/8	6HF	0.125	0.28	1.19	3.81
	<b>650C9H</b>	65,000	9/16	9HF	0.188	0.63	1.63	4.61
<b>Ball Check Valves</b>								
	<b>65BC4H</b>	65,000	1/4	4HF	0.094	0.15	1.19	3.40
	<b>65BC6H</b>	65,000	3/8	6HF	0.125	0.28	1.19	3.81
	<b>65BC9H</b>	65,000	9/16	9HF	0.188	0.63	1.63	4.61

**CAUTION:** FREQUENT INSPECTIONS of O-Rings are necessary to ensure proper service of the check valve. O-Rings have shown satisfactory service life in testing, however different service conditions may lead to variations in cycle and shelf life.

All dimensions are for reference only and subject to change.

\*See page 2 in the Technical Section for determining operating pressures above room temperature.

All general terms and conditions of sale, including limitations of our liability, apply to all products and services sold.  
 MT R4 0215

### Dual-Disc Line Filters

**MAXIMATOR** dual-disc line filters are used to filter process fluids in high pressure systems. This design helps remove the large particles first through a coarse primary disc, which then allows a secondary disc to provide a smaller micron filtration. These filter elements are designed to withstand pressure surges without cracking, flaking, or rupturing. Filter elements come standard in the following micron sizes: 5/8, 8/30, 30/56 (secondary/primary). Filters are rated for temperatures -60 °F to 660 °F\*. All line filters come with glands and collars.

#### Materials

Body, cover, cover gland: 316 series stainless steel  
Element: 300 series stainless steel

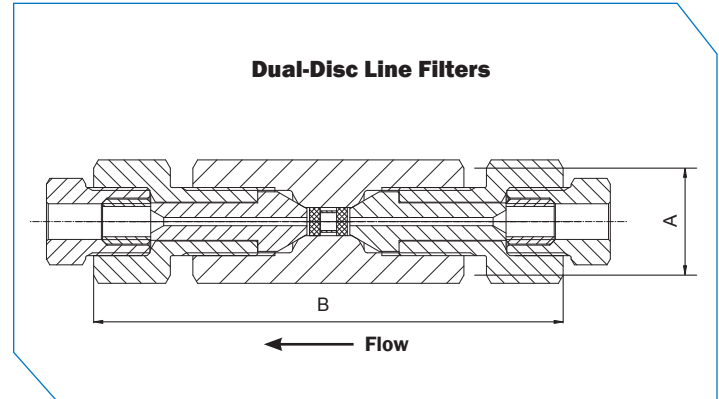

### Cup-Type Line Filters

**MAXIMATOR** cup-type line filters are used when maximum filtration surface area and a single micron size element is preferred. This design increases the filter area as much as 6 times the area of the disc type filter, and will permit higher flow rates with a lower pressure drop, and longer intervals between element changes. Filter elements come standard in 5, 30, or 56 micron sizes and are easily replaced. Filters are rated for temperatures -60 °F to 660 °F\*. All line filters come with glands and collars.

#### Materials:

Body, cover, cover gland: 316 series stainless steel  
Element: 300 series stainless steel

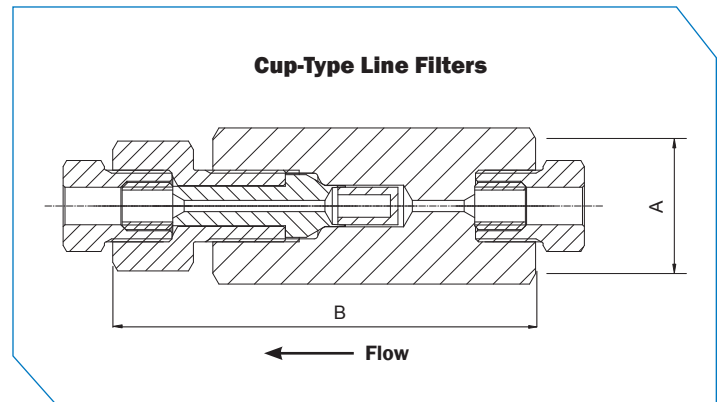

Catalog Number	Pressure Rating (psi)	O.D. Tube (in.)	Connection Type	Orifice (in.)	Micron Size	Filter Element Area (in. <sup>2</sup> )	Dimensions (in.)	
							A (Hex.)	B
<b>Dual-Disc Line Filters</b>								
65DF4H-5/8	65,000	1/4	4HF	0.094	5/8	0.07	1.19	4.81
65DF4H-8/30					8/30			
65DF4H-30/56					30/56			
65DF6H-5/8	65,000	3/8	6HF	0.125	5/8	0.07	1.19	5.18
65DF6H-8/30					8/30			
65DF6H-30/56					30/56			
65DF9H-5/8	65,000	9/16	9HF	0.188	5/8	0.15	1.44	5.73
65DF9H-8/30					8/30			
65DF9H-30/56					30/56			

<b>Cup-Type Line Filters</b>								
65CF4H-5	65,000	1/4	4HF	0.094	5	0.82	1.44	4.25
65CF4H-30					30			
65CF4H-56					56			
65CF6H-5	65,000	3/8	6HF	0.125	5	0.82	1.44	4.41
65CF6H-30					30			
65CF6H-56					56			
65CF9H-5	65,000	9/16	9HF	0.188	5	0.82	1.63	5.28
65CF9H-30					30			
65CF9H-56					56			

It is recommended that all fluids entering a high pressure system be thoroughly cleaned. Maximator filters are designed to remove small amounts of process particles. Pressure differential should not exceed 1000 psi across the filter elements.

All dimensions for reference only and are subject to change.

\*See page 2 in the Technical Section for determining operating pressures above room temperature.

## Angle Filters

**MAXIMATOR** angle filters are used to filter gases or liquids in high pressure systems. The filter elements can be easily changed. The special design allows the exchange of the filter element without the need to first disassemble the filter in front of the tubing. Filter elements are made of sintered material with pore sizes of 5µm, 30 µm or 56 µm. Filters are rated for temperatures -423 °F to 660 °F. All angle filters come with glands and collars.

### Materials

Body: cover, cover gland: 316L series stainless steel

Element: 316 stainless steel

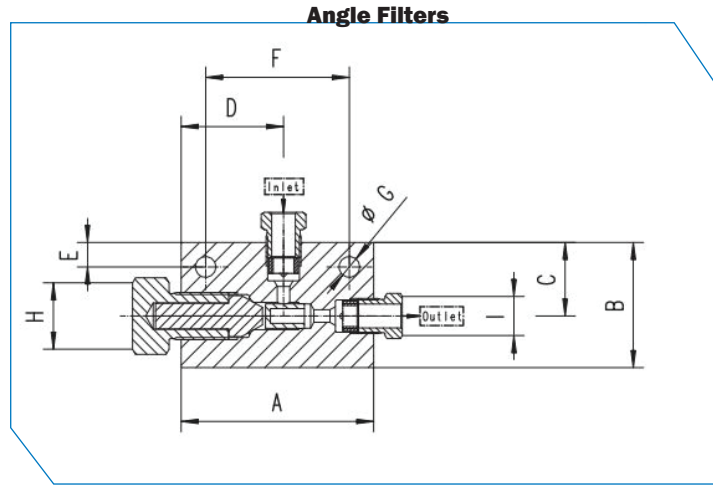

Catalog Number	Pressure Rating psi	Orifice inches	Con-nection Type	Micron Size	Filter Element Areas in <sup>2</sup>	Dimensions (in.)										Block Thickness
						A	B	C	D	E	F	G	H (Hex)	I (Hex)		
65AF4M-5	65,000	0.094	4H	5	0.82	2.8	2.01	1.18	1.65	0.39	2.01	0.34	1.06	0.63	1.02	
65AF4M-30				30												
65AF4M-56				56												
65AF6M-5	65,000	0.125	6H	5	0.82	3.11	2.01	1.18	1.65	0.39	2.32	0.34	1.06	0.81	1.02	
65AF6M-30				30												
65AF6M-56				56												
65AF9M-5	65,000	0.188	9H	5	0.82	3.23	2.64	1.32	1.65	0.39	2.44	0.34	1.06	1.19	1.54	
65AF9M-30				30												
65AF9M-56				56												

*It is recommended that all fluids entering a high pressure system be thoroughly cleaned. Maximator filters are designed to remove small amounts of process particles. Pressure differential should not exceed 1000 psi across the filter elements.*

**MAXIMATOR** safety head assemblies are used to provide over-pressure protection to high pressure systems. These safety head assemblies are to be used with the appropriate 1/4" angular rupture disc listed in the chart below.

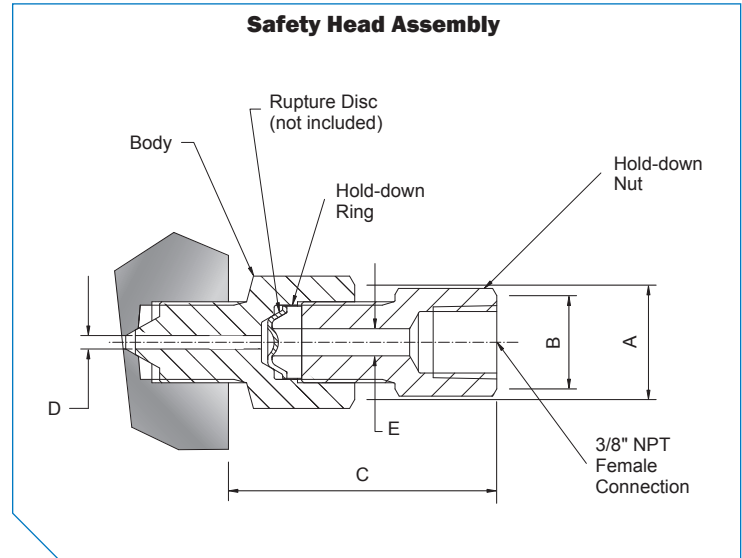
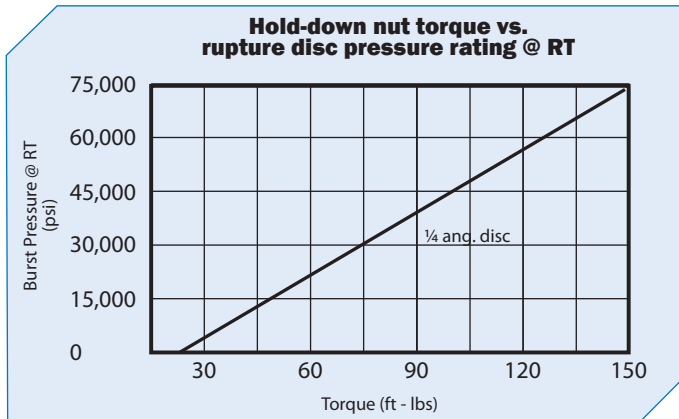

Safety Head Assembly Catalog Number without Disc	Fits Connection Type	O.D. Tube (in.)	Pressure Rating (psi)	Body Torque (ft - lbs.)	Dimensions (in.)				
					A (Hex.)	B (Hex.)	C (LG.)	D (I.D.)	E (I.D.)
<b>65SH4H</b>	4HF	1/4	65,000	25	1.06	0.88	2.56	0.083	0.250
<b>65SH6H</b>	6HF	3/8	65,000	50	1.06	0.88	2.58	0.125	0.250
<b>65SH9H</b>	9HF	9/16	65,000	110	1.19	0.88	2.47	0.188	0.250

See page 2 in the Technical Section for determining operating pressures above room temperature.

All dimensions are for reference only and are subject to change.

## 1/4" Angular Rupture Discs



1/4" angular seat rupture discs are designed to be used with the safety head assemblies that are shown above. Minimum rupture disc pressure ratings should be at least 110% of system operating pressure. The standard rupture disc material is Inconel. The pressure ranges indicated in the table below are at room temperature (72 °F). Other materials and pressure ranges are available upon request.

Catalog Number	Pressure range (psi)	Catalog Number	Pressure range (psi)	Catalog Number	Pressure range (psi)	Catalog Number	Pressure range (psi)
<b>RD-1200</b>	1,164 - 1,272	<b>RD-7000</b>	6,790 - 7,420	<b>RD-17000</b>	16,490 - 18,020	<b>RD-30000</b>	29,100 - 31,800
<b>RD-1500</b>	1,455 - 1,590	<b>RD-7500</b>	7,275 - 7,950	<b>RD-18000</b>	17,460 - 19,080	<b>RD-32500</b>	31,525 - 34,450
<b>RD-1750</b>	1,697 - 1,855	<b>RD-8000</b>	7,760 - 8,480	<b>RD-19000</b>	18,430 - 20,140	<b>RD-35000</b>	33,950 - 37,100
<b>RD-2000</b>	1,940 - 2,120	<b>RD-8500</b>	8,245 - 9,010	<b>RD-20000</b>	19,400 - 21,200	<b>RD-37500</b>	36,375 - 39,750
<b>RD-2500</b>	2,425 - 2,650	<b>RD-9000</b>	8,730 - 9,540	<b>RD-21000</b>	20,370 - 22,260	<b>RD-40000</b>	38,880 - 42,400
<b>RD-3000</b>	2,910 - 3,180	<b>RD-9500</b>	9,215 - 10,070	<b>RD-22000</b>	21,340 - 23,320	<b>RD-42500</b>	41,255 - 45,050
<b>RD-3500</b>	3,395 - 3,710	<b>RD-10000</b>	9,700 - 10,600	<b>RD-23000</b>	22,310 - 24,380	<b>RD-45000</b>	43,650 - 47,700
<b>RD-4000</b>	3,880 - 4,240	<b>RD-11000</b>	10,670 - 11,660	<b>RD-24000</b>	23,280 - 25,440	<b>RD-47500</b>	46,075 - 50,350
<b>RD-4500</b>	4,365 - 4,770	<b>RD-12000</b>	11,640 - 12,720	<b>RD-25000</b>	24,250 - 26,500	<b>RD-50000</b>	48,500 - 53,000
<b>RD-5000</b>	4,850 - 5,300	<b>RD-13000</b>	12,610 - 13,780	<b>RD-26000</b>	25,220 - 27,560	<b>RD-55000</b>	53,350 - 58,300
<b>RD-5500</b>	5,335 - 5,830	<b>RD-14000</b>	13,580 - 14,840	<b>RD-27000</b>	26,190 - 28,620	<b>RD-60000</b>	58,200 - 63,600
<b>RD-6000</b>	5,820 - 6,360	<b>RD-15000</b>	14,550 - 15,900	<b>RD-28000</b>	27,160 - 29,680	<b>RD-67500</b>	65,475 - 71,550
<b>RD-6500</b>	6,305 - 6,890	<b>RD-16000</b>	15,520 - 16,960	<b>RD-29000</b>	28,130 - 30,740	<b>RD-70000</b>	67,900 - 74,200